
V3 DIGITAL SINGLE SCROLL

Commercial Condensing Units

Variable Capacity

Medium Temperature Applications

ISSUE: 01.12.2023



IMPORTANT!

READ BEFORE PROCEEDING!

GENERAL SAFETY GUIDELINES




This guideline is intended for users to ensure safe installation, operation, and maintenance of J & E Hall Digital Single Scroll condensing units. This guideline is not intended to replace the system expertise available from the system manufacturers.

This equipment is a relatively complicated apparatus. During installation, operation, maintenance or service, individuals may be exposed to certain components or conditions including, but not limited to: refrigerants, materials under pressure, rotating components, and both high and low voltage. Each of these items has the potential, if misused or handled improperly, to cause bodily injury or death. It is the obligation and responsibility of operating/service personnel to identify and recognize these inherent hazards, protect themselves, and proceed safely in completing their tasks. Failure to comply with any of these requirements could result in serious damage to the equipment and the property in which it is situated, as well as severe personal injury or death to themselves and people at the site.

This document is intended for use by owner-authorized operating/service personnel. It is expected that these individuals possess independent training that will enable them to perform their assigned tasks properly and safely. It is essential that, prior to performing any task on this equipment, this individual shall have read and understood this document and any referenced materials. This individual shall also be familiar with and comply with all applicable governmental standards and regulations pertaining to the task in question.

SAFETY SYMBOLS

The following symbols are used in this document to alert the reader to specific situations:

 WARNING	Warning! Risk of serious injury or death to person!
 CAUTION	Caution! Danger which can lead to serious damages!
 NOTICE	Notice! Risk of damage to equipment!

NOTICE



Disposal requirement

Your refrigeration product is marked with this symbol. This means that electrical and electronic products shall not be mixed with unsorted household waste. Do not try to dismantle the system yourself: the dismantling of the refrigeration system, treatment of the refrigerant, of oil and of other parts must be done by a qualified installer in accordance with relevant local and national legislation. Refrigeration equipment must be treated at a specialized treatment facility for re-use, recycling and recovery.

By ensuring this product is disposed of correctly, you will help to prevent potential negative consequences for the environment and human health. Please contact J & E Hall for more information.

Batteries must be removed from the controller and disposed of separately in accordance with relevant local and national legislation.

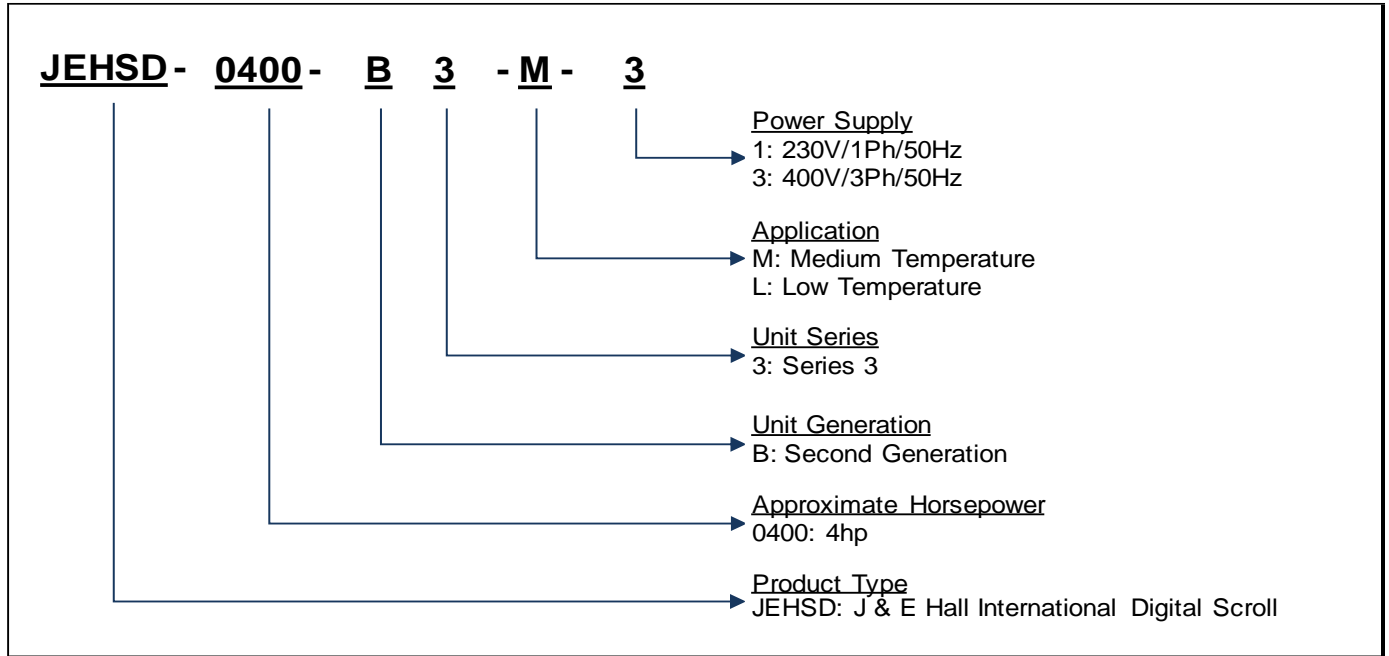
Contents

NOMENCLATURE	1
<i>Figure 1: Product Nomenclature</i>	1
PRODUCT FEATURES	1
SPECIFICATIONS	2
<i>Table 1: Unit Data</i>	2
<i>Table 2: Unit Dimensions and Weight</i>	2
<i>Table 3: SEPR Data and Sound</i>	2
PERFORMANCE DATA	3
<i>Table 4: R407A: 10K SH / OK SC</i>	3
<i>Table 5: R407F: 10K SH / OK SC</i>	4
<i>Table 6: R448A/R449A: 10K SH/OK SC</i>	5
<i>Table 7: R407A: 20°C RGT / OK SC</i>	6
<i>Table 8: R407F: 20°C RGT / OK SC</i>	7
<i>Table 9: R448A/R449A: 20°C RGT/OK SC</i>	8
APPLICATION GUIDELINES	9
<i>Table 10: Application Envelope</i>	9
DIGITAL SCROLL COMPRESSOR	9
CRANKCASE HEATERS	9
LOW PRESSURE SWITCH.....	9
<i>Figure 2: Low Pressure Switch Setting</i>	9
HEALTH AND SAFETY	9
GENERAL INFORMATION	9
INSTALLATION	10
UNIT LOCATION	10
<i>Figure 3: Positioning of Condensing Unit</i>	10
<i>Figure 4: Air Circulation for Condenser</i>	10
INSTALLATION CLEARANCES.....	11
<i>Figure 5: Installation Clearance</i>	11
FIELD PIPING	11
<i>Figure 6: Piping Layout for Outdoor Above Indoor</i> ...	11
<i>Figure 7: Piping Layout for Outdoor Below Indoor</i> ...	12
PRESSURE TESTING	12
<i>Table 11: Test Pressure</i>	12
EVACUATION AND CHARGING	12
ELECTRICAL	13
<i>Table 12: Recommended Cable Size and Fuse</i>	13
REVERSE ROTATION PROTECTION AND VOLTAGE UNBALANCE	13
COMMISSIONING	14
ACCESS TO CONTROLLER AND LCD DISPLAY	14
<i>Figure 8: Access Point</i>	14
PRE STARTUP CHECKS	14
RUNNING THE UNIT	14
<i>Table 13: Factory Default Settings</i>	14
USER TERMINAL INTERFACE – LCD DISPLAY	15
<i>Figure 9: LCD Display</i>	15
<i>Table 14: LCD Display Button Functions</i>	15
CONTROLLER HOME SCREEN.....	15
SWITCH UNIT ON / OFF (BY CONTROLLER)	15
CHANGING SET POINT AND REFRIGERANT SELECTION	16
ALTERING LOW PRESSURE ALARM NOTIFICATION SETTING (OPTIONAL).....	16
<i>Table 15: Low Pressure Notification Alarm</i>	17
COMPRESSOR OPERATION FOR CAPACITY REGULATION.....	17
<i>Figure 10: Regulation Request Versus Setpoint</i>	17

<i>Figure 11: Neutral Zone Timings Versus Setpoint</i>	17
PRESSURE SWITCHES SETTINGS (MECHANICAL)	18
<i>High Pressure Safety Switch</i>	18
<i>Low Pressure Protection Switch</i>	18
<i>Table 16: Low- and High-Pressure Switch Settings</i>	18
AC FAN SPEED MODULATION	18
<i>Figure 12: Fan Control Curve</i>	18
<i>Table 17: Fan Speed Controller Settings</i>	18
MANUAL BYPASS OPERATION	18
ALARM INFORMATION	19
<i>Table 18: Alarm Default Settings</i>	19
<i>Table 19: Error Code</i>	19
<i>Table 20: LCD Display - Alarm Status</i>	19
BACNET AND MODBUS PROTOCOL.....	19
<i>Table 21: Serial Cards for Different Protocol</i>	19
SERVICE & MAINTENANCE	20
F-GAS REQUIREMENT	21
<i>Table 22: Tonnes CO₂ Equivalent</i>	21
<i>Table 23: Leak Inspection Frequency</i>	21
APPENDIX	21
<i>Table 24: Tightening Torque</i>	21
<i>Figure 13: Outline Dimension JEHS-D-0400-B3-M-3, JEHS-D-0600-B3-M-3</i>	22
<i>Figure 14: Outline Dimension JEHS-D-0800-B4-M-3</i> ..	22
<i>Figure 15: Wiring Diagram JEHS-D-0400-B3-M-3, JEHS-D-0600-B3-M-3</i>	23
<i>Figure 16: Wiring Diagram JEHS-D-0800-B4-M-3</i>	24
<i>Figure 17: Declaration of Conformity</i>	25
<i>Figure 18: Declaration of Incorporation</i>	26
<i>Figure 19: EU Declaration of Conformity</i>	27
<i>Figure 20: EU Declaration of Incorporation</i>	28

Nomenclature

Figure 1: Product Nomenclature



Product Features

J & E Hall Digital Single Scroll is a packaged condensing unit adopt digital scroll technology for precise control on room temperature and humidity. The unit needs to be connected to indoor units via copper connecting pipes to provide refrigeration cooling. The system is suitable for medium temperature applications such as cold rooms, display cabinets in convenience stores, general food storage, milk cooling, industrial processes etc.

Standard features for all medium temperature model:

- Copeland hermetic digital scroll compressor – ZBD (Digital)
- Capacity modulation control
- Vertical liquid receiver with 3/8” NPT plug
- Fitted liquid line drier and sight glass
- Oil separator and discharge line check valve
- External service valves
- High- and low-pressure transducers
- Manual low-pressure switch (adjustable)
- High pressure safety switch (auto reset cartridge type)
- Flexible pressure hoses
- IP rated enclosure
- Mains isolator
- Manual motor starter with short circuit and overload protection
- Contactor for compressor
- Advanced programmable controller provides modulation control based on suction pressure, protection, and diagnostics.
- LCD display
- Step down transformer 240V to 24V
- Fuse protection on controller, fan speed controller and backup system
- Mechanical by-pass circuit
- Branded AC fan
- Fan speed controller
- Alarm relay (volt free)
- Crankcase heater on compressor
- Acoustic insulation to compressor compartment
- Operates with refrigerants R407A, R407F, R448A, R449A
- BACnet and Modbus Protocol feature

Specifications

Table 1: Unit Data

Model	Compressor				Oil Separator	Electrical Data						Unit Connections		Coil Volume	Liquid Receiver	Air flow
	Model	Displacement	Charge Limit	Oil Charge		Compressor				Fan		Liquid	Suction			
		(m ³ /h)	(kg)	(L)	(L)	NC (A)	MOC (A)	MCC (A)	LRC (A)	No.	Total FLC (A)	(inch)	(inch)	(L)	(L)	(m ³ /h)
JEHSD-0400-B3-M-3	ZBD29KQE-TFD	11.4	3.6	1.36	0.6	5.7	7.9	10.8	48	1	0.9	1/2"	7/8"	4.42	7.6	4250
JEHSD-0600-B3-M-3	ZBD45KQE-TFD	17.1	4.8	1.89	0.6	8.6	11.4	13.5	74	1	0.9	1/2"	7/8"	6.89	7.6	4100
JEHSD-0800-B4-M-3	ZBD57KCE-TFD	21.4	4.8	1.89	0.6	10.4	15.9	21.3	102	2	1.8	3/4"	1-1/8"	8.73	13.6	8500

- Compressor Lubricant: Polyolester Oil – (Copeland Ultra 32 CC, Copeland Ultra 32-3MAF, Mobil EAL Artic 22 CC, Uniquema Emkarate RL32CF)
- NC: Nominal Current @ condition -10°C Te/ +32°C Ta
- MOC: Maximum Operating Current
- MCC: Maximum Continuous Current before compressor protector trip
- LRC: Locked Rotor Current
- FLC: Full Load Current

Table 2: Unit Dimensions and Weight

Model	Overall Dimensions (mm)			Mounting Dimensions (mm)		Dry Weight	Gross Weight
	Width	Depth	Height	Width	Depth	(kgs)	(kgs)
JEHSD-0400-B3-M-3	1353	575	872	945	500	128	166
JEHSD-0600-B3-M-3	1353	575	872	945	500	134	172
JEHSD-0800-B4-M-3	1348	612	1727	940	560	213	272

Table 3: SEPR Data and Sound

Unit Model	SEPR (10K SH)				SEPR (20°C RGT)				SPL @ 10m dB(A)
	R407A	R407F	R448A	R449A	R407A	R407F	R448A	R449A	Loaded
JEHSD-0400-B3-M-3	3.26	3.23	3.15	3.15	3.31	3.25	3.20	3.20	39
JEHSD-0600-B3-M-3	3.24	3.08	2.93	2.93	3.30	3.10	2.98	2.98	40
JEHSD-0800-B4-M-3	2.75	2.84	2.75	2.75	2.81	2.86	2.81	2.81	44

- Seasonal Energy Performance Ratio (SEPR) rating condition @ condition -10°C Te
- SH: Suction superheat
- RGT: Return gas temperature
- Sound Pressure Level (SPL) measured in an anechoic room at -10°C Te/+32°C Ta. Alternative conditions may produce different results.

Performance Data

The performance data shown in **Table 4 to 9** has the following criteria:

- Te: Evaporating Temperature
- Ta: Ambient Temperature
- CC: Cooling Capacity (Watts)
- PC: Power Consumption (Watts)
- RGT: Return Gas Temperature
- SH: Suction Superheat
- SC: Subcooling
- COP: Coefficient of Performance

Table 4: R407A: 10K SH / 0K SC

MODEL	Ta	Te		-20	-15	-10	-5	0	5
JEHSD-0400-B3-M-3	27		CC	4540	5650	6900	8310	9940	11850
	27		PC	2510	2590	2680	2780	2890	3000
	27		COP	1.81	2.18	2.57	2.99	3.44	3.95
	32		CC	4210	5270	6440	7790	9380	11250
	32		PC	2770	2870	2970	3070	3160	3240
	32		COP	1.52	1.84	2.17	2.54	2.97	3.47
	35		CC		5030	6160	7480	9040	10900
	35		PC		3050	3160	3250	3340	3400
	35		COP		1.65	1.95	2.30	2.71	3.21
	38		CC		4790	5880	7150	8680	10550
	38		PC		3250	3360	3450	3530	3570
	38		COP		1.47	1.75	2.07	2.46	2.96
	43		CC			5410	6610	8080	9890
	43		PC			3720	3820	3880	3900
43		COP			1.45	1.73	2.08	2.54	
JEHSD-0600-B3-M-3	27		CC	6530	8070	9870	11950	14300	16950
	27		PC	3600	3810	4020	4240	4440	4630
	27		COP	1.81	2.118	2.455	2.818	3.221	3.661
	32		CC	6030	7470	9150	11050	13200	15550
	32		PC	4040	4260	4490	4740	5000	5240
	32		COP	1.49	1.754	2.038	2.331	2.64	2.968
	35		CC		7290	8700	10500	12500	14650
	35		PC		4410	4820	5090	5370	5660
	35		COP		1.65	1.80	2.06	2.33	2.59
	38		CC		6750	8240	9920	11750	
	38		PC		4900	5170	5460	5780	
	38		COP		1.38	1.59	1.82	2.03	
	43		CC						
	43		PC						
43		COP							
JEHSD-0800-B4-M-3	27		CC	8680	10700	13100	15900	19100	22800
	27		PC	5280	5590	5900	6190	6440	6610
	27		COP	1.64	1.91	2.22	2.57	2.97	3.45
	32		CC	8120	10000	12200	14750	17650	20900
	32		PC	5800	6130	6480	6840	7190	7500
	32		COP	1.40	1.63	1.88	2.16	2.45	2.79
	35		CC		9600	11700	14050	17000	
	35		PC		6480	6870	7280	7530	
	35		COP		1.48	1.70	1.93	2.26	
	38		CC			11150	13350		
	38		PC			7280	7740		
	38		COP			1.53	1.72		
	43		CC						
	43		PC						
43		COP							

Table 5: R407F: 10K SH / OK SC

MODEL	Ta Te			-20	-15	-10	-5	0	5
	Ta	Te							
JEHSD-0400-B3-M-3	27		CC		6080	7380	8900	10700	12850
	27		PC		2830	2940	3040	3130	3200
	27		COP		2.15	2.51	2.93	3.42	4.02
	32		CC		5660	6910	8350	10050	12150
	32		PC		3150	3260	3350	3430	3490
	32		COP		1.80	2.12	2.49	2.93	3.48
	35		CC		5400	6600	8000	9670	11650
	35		PC		3360	3470	3570	3650	3700
	35		COP		1.61	1.90	2.24	2.65	3.15
	38		CC			6290	7640	9250	11200
	38		PC			3700	3800	3880	3930
	38		COP			1.70	2.01	2.38	2.85
	43		CC				7030	8550	
	43		PC				4220	4290	
	43		COP				1.67	1.99	
JEHSD-0600-B3-M-3	27		CC	7230	8770	10500	12450	14550	16800
	27		PC	3510	3900	4330	4790	5250	5710
	27		COP	2.06	2.25	2.42	2.60	2.77	2.94
	32		CC	6410	7990	9730	11650	13700	15950
	32		PC	3870	4280	4720	5180	5650	6090
	32		COP	1.66	1.87	2.06	2.25	2.42	2.62
	35		CC		7670	9170	11100	13200	15450
	35		PC		4410	4980	5440	5900	6340
	35		COP		1.74	1.84	2.04	2.24	2.44
	38		CC			8520	10500		
	38		PC			5250	5710		
	38		COP			1.62	1.84		
	43		CC						
	43		PC						
	43		COP						
JEHSD-0800-B4-M-3	27		CC	8880	10900	13300	15950	18950	22300
	27		PC	5210	5530	5860	6210	6560	6880
	27		COP	1.70	1.97	2.27	2.57	2.89	3.24
	32		CC	8300	10250	12450	15000	17850	21000
	32		PC	5730	6040	6400	6760	7130	7480
	32		COP	1.45	1.70	1.95	2.22	2.50	2.81
	35		CC		9830	12000	14400	17150	20100
	35		PC		6380	6740	7120	7500	7880
	35		COP		1.54	1.78	2.02	2.29	2.55
	38		CC			11500	13800	16400	
	38		PC			7110	7500	7900	
	38		COP			1.62	1.84	2.08	
	43		CC						
	43		PC						
	43		COP						

Table 6: R448A/R449A: 10K SH/OK SC

MODEL	Ta Te			-20	-15	-10	-5	0	5	10
	Ta	Te								
JEHSD-0400-B3-M-3	27		CC	4610	5630	6800	8110	9600	11300	13150
	27		PC	2480	2660	2840	3000	3170	3340	3530
	27		COP	1.86	2.12	2.39	2.70	3.03	3.38	3.73
	32		CC	4320	5280	6380	7610	9010	10600	12450
	32		PC	2630	2860	3060	3260	3450	3630	3810
	32		COP	1.64	1.85	2.08	2.33	2.61	2.92	3.27
	35		CC	4130	5060	6110	7300	8660	10250	12000
	35		PC	2720	2980	3210	3420	3620	3800	3980
	35		COP	1.52	1.70	1.90	2.13	2.39	2.70	3.02
	38		CC	3940	4830	5840	6980	8300	9830	11600
	38		PC	2790	3090	3350	3580	3790	3980	4160
	38		COP	1.41	1.56	1.74	1.95	2.19	2.47	2.79
	43		CC		4460	5390	6460	7690	9150	10850
	43		PC		3250	3570	3840	4080	4280	4460
	43		COP		1.37	1.51	1.68	1.88	2.14	2.43
JEHSD-0600-B3-M-3	27		CC	6760	8280	9930	11700	13650	15750	18050
	27		PC	3440	3830	4260	4720	5220	5770	6360
	27		COP	1.97	2.16	2.33	2.48	2.61	2.73	2.84
	32		CC	6220	7700	9320	11050	13000	15100	17450
	32		PC	3800	4210	4630	5100	5580	6100	6640
	32		COP	1.64	1.83	2.01	2.17	2.33	2.48	2.63
	35		CC	5860	7540	8910	10650	12550	14700	17100
	35		PC	4060	4320	4890	5350	5810	6290	6790
	35		COP	1.44	1.75	1.82	1.99	2.16	2.34	2.52
	38		CC	5500	6940	8490	10200	12100	14250	
	38		PC	4330	4750	5180	5620	6060	6510	
	38		COP	1.27	1.46	1.64	1.81	2.00	2.19	
	43		CC		6280	7790	9480			
	43		PC		5240	5670	6090			
	43		COP		1.20	1.37	1.56			
JEHSD-0800-B4-M-3	27		CC	8720	10700	13000	15650	18750	22400	26700
	27		PC	4320	4730	5200	5730	6310	6940	7600
	27		COP	2.02	2.26	2.50	2.73	2.97	3.23	3.51
	32		CC	8370	10200	12300	14650	17300	20400	23900
	32		PC	4550	4990	5510	6110	6780	7520	8330
	32		COP	1.84	2.04	2.23	2.40	2.55	2.71	2.87
	35		CC	8160	9910	11850	14000	16400	19100	
	35		PC	4700	5170	5730	6390	7140	7980	
	35		COP	1.74	1.92	2.07	2.19	2.30	2.39	
	38		CC	7940	9610	11450	13400	15500		
	38		PC	4880	5370	5970	6700	7550		
	38		COP	1.63	1.79	1.92	2.00	2.05		
	43		CC	7530	8960	10350				
	43		PC	5260	5870	6710				
	43		COP	1.43	1.53	1.54				

Table 7: R407A: 20° C RGT / OK SC

MODEL	Ta / Te		-20	-15	-10	-5	0	5
JEHSD-0400-B3-M-3	27	CC		5820	7050	8450	10050	11900
	27	PC		2590	2680	2780	2890	3000
	27	COP		2.25	2.63	3.04	3.48	3.97
	32	CC			6620	7960	9520	11350
	32	PC			2970	3070	3160	3240
	32	COP			2.23	2.59	3.01	3.50
	35	CC			6360	7660	9180	11000
	35	PC			3160	3250	3340	3400
	35	COP			2.01	2.36	2.75	3.24
	38	CC				7350	8840	10650
	38	PC				3450	3530	3570
	38	COP				2.13	2.50	2.98
	43	CC				6830	8250	9990
	43	PC				3820	3880	3900
	43	COP				1.79	2.13	2.56
JEHSD-0600-B3-M-3	27	CC		8320	10150	12200	14500	17050
	27	PC		3810	4020	4240	4440	4630
	27	COP		2.18	2.52	2.88	3.27	3.68
	32	CC			9450	11350	13400	15700
	32	PC			4490	4740	5000	5240
	32	COP			2.10	2.39	2.68	3.00
	35	CC				10800	12750	14800
	35	PC				5090	5370	5660
	35	COP				2.12	2.37	2.61
	38	CC				10250	12000	
	38	PC				5460	5780	
	38	COP				1.88	2.08	
	43	CC						
	43	PC						
	43	COP						
JEHSD-0800-B4-M-3	27	CC		11050	13450	16200	19400	23000
	27	PC		5590	5900	6190	6440	6610
	27	COP		1.98	2.28	2.62	3.01	3.48
	32	CC			12650	15150	17950	21100
	32	PC			6480	6840	7190	7500
	32	COP			1.95	2.21	2.50	2.81
	35	CC				14450	17050	
	35	PC				7280	7690	
	35	COP				1.98	2.22	
	38	CC						
	38	PC						
	38	COP						
	43	CC						
	43	PC						
	43	COP						

Table 8: R407F: 20° C RGT / OK SC

MODEL	Ta	Te		-20	-15	-10	-5	0	5
JEHSD-0400-B3-M-3	27	CC			6170	7480	8980	10750	12850
	27	PC			2830	2940	3040	3130	3200
	27	COP			2.18	2.54	2.95	3.43	4.02
	32	CC				7030	8460	10150	12200
	32	PC				3260	3350	3430	3490
	32	COP				2.16	2.53	2.96	3.50
	35	CC				6740	8130	9760	11700
	35	PC				3470	3570	3650	3700
	35	COP				1.94	2.28	2.67	3.16
	38	CC					7780	9360	11250
	38	PC					3800	3880	3930
	38	COP					2.05	2.41	2.86
	43	CC						8690	
	43	PC						4290	
	43	COP						2.03	
JEHSD-0600-B3-M-3	27	CC			8920	10650	12600	14650	16850
	27	PC			3900	4330	4790	5250	5710
	27	COP			2.29	2.46	2.63	2.79	2.95
	32	CC				9950	11850	13900	16050
	32	PC				4720	5180	5650	6090
	32	COP				2.11	2.29	2.46	2.64
	35	CC					11350	13400	15550
	35	PC					5440	5900	6340
	35	COP					2.09	2.27	2.45
	38	CC							
	38	PC							
	38	COP							
	43	CC							
	43	PC							
	43	COP							
JEHSD-0800-B4-M-3	27	CC				13500	16150	19100	22400
	27	PC				5860	6210	6560	6880
	27	COP				2.30	2.60	2.91	3.26
	32	CC				12750	15250	18050	21100
	32	PC				6400	6760	7130	7480
	32	COP				1.99	2.26	2.53	2.82
	35	CC					14700	17350	20300
	35	PC					7120	7500	7880
	35	COP					2.06	2.31	2.58
	38	CC						16650	
	38	PC						7900	
	38	COP						2.11	
	43	CC							
	43	PC							
	43	COP							

Table 9: R448A/R449A: 20° C RGT/OK SC

MODEL	Ta Te		-20	-15	-10	-5	0	5	10
JEHSD-0400-B3-M-3	27	CC	4790	5820	6980	8280	9730	11350	13150
	27	PC	2480	2660	2840	3000	3170	3340	3530
	27	COP	1.93	2.19	2.46	2.76	3.07	3.40	3.73
	32	CC	4530	5490	6590	7800	9170	10700	12450
	32	PC	2630	2860	3060	3260	3450	3630	3810
	32	COP	1.72	1.92	2.15	2.39	2.66	2.95	3.27
	35	CC		5290	6340	7510	8830	10350	12000
	35	PC		2980	3210	3420	3620	3800	3980
	35	COP		1.78	1.98	2.20	2.44	2.72	3.02
	38	CC		5080	6080	7210	8480	9930	11600
	38	PC		3090	3350	3580	3790	3980	4160
	38	COP		1.64	1.81	2.01	2.24	2.49	2.79
	43	CC			5660	6710	7890	9270	10850
	43	PC			3570	3840	4080	4280	4460
	43	COP			1.59	1.75	1.93	2.17	2.43
JEHSD-0600-B3-M-3	27	CC	7010	8550	10200	12000	13900	15900	18050
	27	PC	3440	3830	4260	4720	5220	5770	6360
	27	COP	2.04	2.23	2.39	2.54	2.66	2.76	2.84
	32	CC	6520	8020	9640	11350	13250	15250	17450
	32	PC	3800	4210	4630	5100	5580	6100	6640
	32	COP	1.72	1.90	2.08	2.23	2.37	2.50	2.63
	35	CC		7870	9260	10950	12850	14850	17100
	35	PC		4320	4890	5350	5810	6290	6790
	35	COP		1.82	1.89	2.05	2.21	2.36	2.52
	38	CC			8870	10550	12400	14450	
	38	PC			5180	5620	6060	6510	
	38	COP			1.71	1.88	2.05	2.22	
	43	CC			8220	9870			
	43	PC			5670	6090			
	43	COP			1.45	1.62			
JEHSD-0800-B4-M-3	27	CC	9070	11050	13350	15950	19000	22500	26700
	27	PC	4310	4730	5200	5730	6310	6940	7600
	27	COP	2.10	2.34	2.57	2.78	3.01	3.24	3.51
	32	CC	8760	10600	12700	15000	17650	20600	23900
	32	PC	4540	4990	5520	6110	6780	7520	8330
	32	COP	1.93	2.12	2.30	2.45	2.60	2.74	2.87
	35	CC		10350	12300	14450	16800	19300	
	35	PC		5170	5730	6390	7140	7980	
	35	COP		2.00	2.15	2.26	2.35	2.42	
	38	CC		10050	11900	13850	15900		
	38	PC		5370	5970	6700	7550		
	38	COP		1.87	1.99	2.07	2.11		
	43	CC			10850				
	43	PC			6710				
	43	COP			1.62				

Application Guidelines



NOTICE It should ensure that the refrigeration system which adopts this condensing unit **MUST** have a liquid line solenoid valve controlled by a thermostat for each evaporator. Failure to fulfill this requirement causes liquid compression and consequently reduces lifetime of compressor.



CAUTION

Ensure that new compressors are not subjected to liquid abuse. Turn the crankcase heater **ON** for 12 hours before starting the compressor to avoid oil dilution and bearing malfunction.

Table 10: Application Envelope

Operating Limits	Recommendation
Discharge gas temperature	Maximum 120°C (defaulted in software)
Condenser coil temperature	Maximum 60°C (defaulted in software)
Low pressure side	Minimum 0.5barg; Maximum 19barg
High pressure side	Maximum 28barg
Evaporator outlet superheat	Above 6K (to avoid liquid flood back)
Suction gas superheat at compressor inlet	Not more than 20K
Voltage supply	Min: 360V, Max: 440V
Phase asymmetry	+/- 2%
Frequency	50Hz +/- 1%
Outdoor ambient	Min: -15°C, Max: 43°C (with standard wiring: fan speed controller in the circuit)
Maximum pipe run	50m

Suction line shall be insulated to avoid:

- High superheat during high ambient condition can create high discharge temperature.
- Too low superheat during low ambient condition that can condense refrigerant inside suction line.

Digital Scroll Compressor

- Three phase scroll compressor motors are designed to run only in one direction. The correct rotation of a three-phase compressor motor depends on the connection of the three incoming phases to the unit. Correct rotation can be determined by a drop in suction pressure and a rise in discharge pressure when the compressor is energized. Running the compressor for a short period of time in reverse direction will have no negative impact but prolonged running in reverse direction may cause premature failure.
- A clicking sound is audible during compressor start-up and shut down, it is entirely normal and has no effect on compressor durability.

Crankcase Heaters

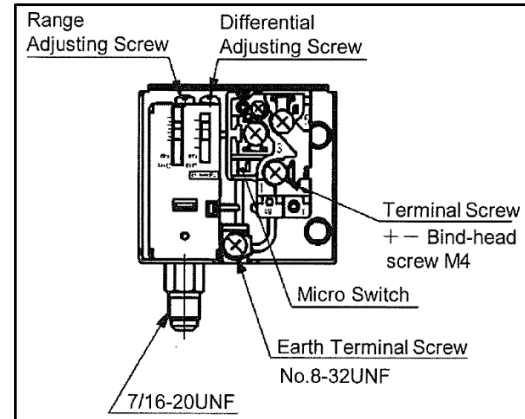
- Crankcase heater is required to remain energized during the compressor off cycles. The initial start in the field is a very critical period for any new compressor because all load-bearing surfaces are new and require a short break-in period to carry high loads under adverse conditions. Thus, the crankcase heater must be turned on a minimum of 12 hours before the

first-time start, to prevent oil dilution and bearing stress on initial start-up.

- To energize the crankcase heater while keeping compressor OFF, turn the isolator switch to ON position and motor rated circuit breaker to OFF position.

Low Pressure Switch

Figure 2: Low Pressure Switch Setting



The pressure switch fitted to condensing units with auto reset for low pressure is factory preset to 1.0 bar cut-out. **Do not set low pressure cut-out lower than factory default setting.**

Setting procedure for Low Pressure switch

- **Range:** Turning the range adjusting screw (2) clockwise will decrease the cut-in pressure setting. Turning the range adjusting screw anti-clockwise will increase the cut-in pressure setting.
- **Differential:** Turning the differential adjusting screw (3) clockwise will increase the differential pressure setting. Turning the differential adjusting screw anti-clockwise will decrease the differential pressure setting.
- Lock the spindle with locking plate after setting.

Health and Safety



CAUTION

Only qualified personnel, who are familiar with refrigeration systems and components including all controls, should perform the installation and start-up of the system. To avoid potential injury, use care when working around coil surfaces or sharp edges of metal cabinets. All piping and electrical wiring should be installed in accordance with all applicable standards and local by-laws.

General information

Before Installation


- Ensure the units received are the correct models for the intended application.
- Ensure the refrigerant, electrical supply and maximum working pressure are all suitable for the proposed application.
- Check there is no damage to the units. Any damage should be reported to the supplier immediately.

- Check that the proposed equipment locations are suitable and provide adequate support for the weight of the units.

Offloading and Lifting

- Whenever a condensing unit is lifted, it should be from the base and, where possible, all packing and protection is kept in position.
- If lifting equipment is required, ensure that it is suitable, certificated, and that the operators are qualified to use it.
- When using a fork-lift or pallet truck to lift the unit, the two support points should be sufficiently apart to give stability when lifting and suitably placed to distribute the load on the forks.
- If slings are used, care should be taken to ensure that the slings do not crush the casework or coil.
- When lifting by crane, use spreader bars to prevent compressing the top of the equipment.
- Do not drop the unit. Should this inadvertently happen, it should be immediately unpacked and inspected for damage.
- Use the appropriate spreader bars/lifting sling with the holes and lugs provided.

During Installation and subsequent maintenance

- Installation and maintenance are to be performed only by qualified personnel who are familiar with local codes and regulations and experienced with this type of equipment.
- Safe working methods are identified, and operators have suitable Personal Protective Equipment (PPE).
- Ensure the working area has adequate ventilation during brazing procedures.
- The units contain moving machinery and electrical power hazards, which may cause severe injury or death. Disconnect and shut off power before installation or service of the equipment.
- Refrigerant release into the atmosphere is illegal. Proper evacuation, recovery, handling, and leak testing procedures must be observed all the time.
- Units must be **grounded to the screw terminal labelled** 
- No maintenance work should be attempted prior to disconnecting the electrical supply.
- The electrical covers and fan guards must remain fitted all the time.
- Use of the units outside of the design conditions and the application for which the units were intended may be unsafe and be detrimental to the units, regardless of short- or long-term operation.
- The units are not designed to withstand loads or stress from other equipment or personnel. Such extraneous loads or stress may cause failure/leak/injury.
- The units are not designed to operate with any restrictions such as heavy snowfall around them. Additional measures (such as shielding of the units) shall be implemented as required.
- The installer must fix the unit securely on installation using the M8 bolt holes in the unit feet to prevent instability from accidental contact or from exposure to the elements (e.g.: wind).
- When the compressor operates under stabilized conditions, the oil level must be visible in the sight glass.

Foam filling the oil sight glass indicates presence of large concentration of liquid to the compressor.

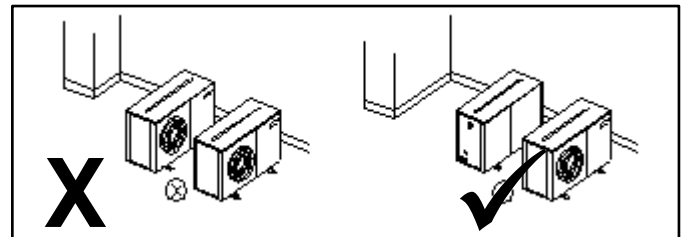
- No additional oil is required for installation with good oil returns, line runs up to 20m. Additional oil might be required if lines exceeded 20m, with minimum oil level must not lower than 1/4 of sight glass. Top-up the oil while compressor is idle, via suction schrader connector with a suitable pump.
- Ensure correct rotation of compressor. If there is no compression, shut off the incoming power supply and swap connection of any two of the three incoming phases at the condensing unit's isolator switch.

Installation

Unit location

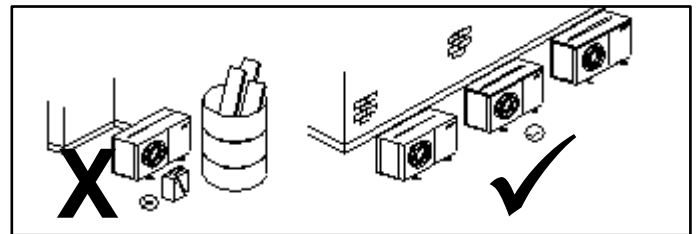
- To achieve maximum cooling capacity, the installation location for the condensing unit should be carefully selected.
- Install the condensing unit in such a way so that hot air ejected by the condensing unit cannot be drawn in again (short circuit of hot discharge air). Allow sufficient space for maintenance around the unit.

Figure 3: Positioning of Condensing Unit



- Ensure that there is no obstruction to air flow into or out of the unit. Remove obstacles which block air intake or discharge.

Figure 4: Air Circulation for Condenser



- The location must be well ventilated, so the unit can draw in and distribute plenty of air thus lowering the condensing temperature.
- To optimize the unit running conditions, the condenser coil must be cleaned at regular intervals.
- The unit must be level in all directions.
- It is recommended to install the unit on rubber grommet or vibration dampers.
- Models JEHSD-0400-B3-M-3 and JEHSD-0600-B3-M-3 are suitable for both ground and wall mounting on brackets, but JEHSD-0800-B4-M-3 is only suitable for ground mounting.



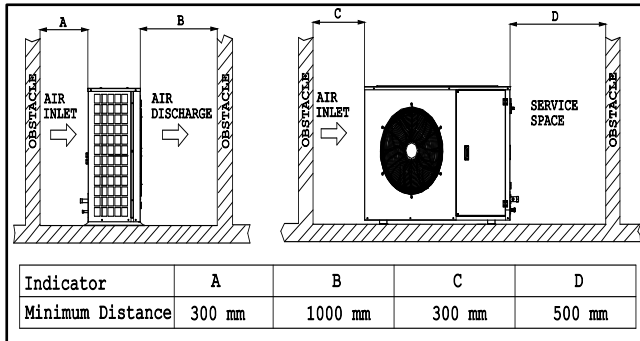
Special attention should be given if unit installed near to the sea as this can reduce unit lifespan due to corrosion of metal parts.

NOTICE

Installation clearances

- The installation location should allow sufficient space for air flow and maintenance around the unit.

Figure 5: Installation Clearance



Field Piping



Pipe sizing should only be determined by qualified personnel. Correct line sizing will minimize the pressure drop and maintain sufficient gas velocity for proper oil return. All applicable standards must be observed in the installation of refrigerant piping.

NOTICE

To ensure satisfactory operation and performance, the following points should be noted:

- Pipework routes must be as simple and as short as possible.
- Avoid low points on pipework where oil can accumulate.
- Use only clean, dehydrated refrigeration grade copper tube with long radius bends.
- Avoid flare type connections and take great care when brazing. Use brazing filler alloys containing phosphorus such as BCuP-7 without flux for joining copper tubes.
- Dissimilar metals such as copper and brass shall be joined using an appropriate flux with high silver content filler material such as BAg-34. Apply flux sparingly to the clean tube only and in a manner to avoid leaving any excess inside of completed joints.
- Run braze without over filling to ensure there is no leakage into the tube.
- To prevent oxidation, blow oxygen free nitrogen through pipework when brazing.
- To prevent condensation on pipe surface, install insulation on all suction lines and on all pipes penetrating walls or passing through hot areas.
- Adequately support all pipe work at a maximum of 2-meter intervals.
- Suction gas velocity must more than 4m/s for horizontal pipe and 8~12m/s for vertical pipe, to ensure good oil return.
- For the condensing unit located above the indoor unit, the use of U-trap and double suction risers is often required. These suction risers must always be fitted with a U-trap at the bottom and a P-trap at the top and

never be higher than 4m unless a second U-trap system is fitted (**Figure 6**).

- Liquid lines should be sized to ensure a full supply of liquid refrigerant to the expansion device.
- For the condensing unit located below the indoor unit (evaporator / display case), attention should be paid to the sizing of liquid lines on vertical riser by limiting the maximum rise to 6m (**Figure 7**).
- For the outdoor unit located below indoor unit: Inverted P-trap is necessary when pump down is not used. To prevent refrigerant from draining into the compressor during off-cycle (**Figure 7**).
- Suction pipework should slope gently back towards the unit to assist oil return to the compressor. A fall of approximately 2cm per meter of pipework is acceptable.
- Additional oil may be required if piping length exceeds 20m or multiple oil traps are fitted. Check the oil level closely during commissioning and add oil, as necessary. Add oil in small amounts. **Do not overfill the compressor!**
- In some circumstances, a suction accumulator (not supplied) may be required. It offers protection against liquid refrigerant flow back during operation and against off-cycle migration by adding internal free volume to the suction side of the system.
- Tests must be conducted to ensure the amount of off-cycle migration to the compressor does not exceed the compressor's charge limit.
- Wherever possible the system should be installed to utilize a pump down configuration.
- The maximum recommended pipe length is 50m.
- It is recommended to install Pressure Relief Valve on the liquid receiver if there is a risk of fire incidence. Increasing temperature will lead to pressure increase in receiver.
- No valves and detachable joints shall be in areas accessible to the public except when they comply with EN 16084.

Figure 6: Piping Layout for Outdoor Above Indoor

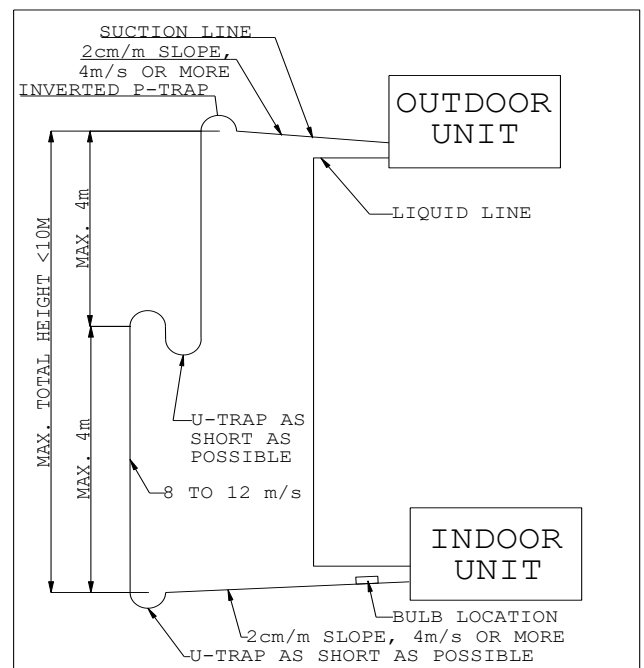
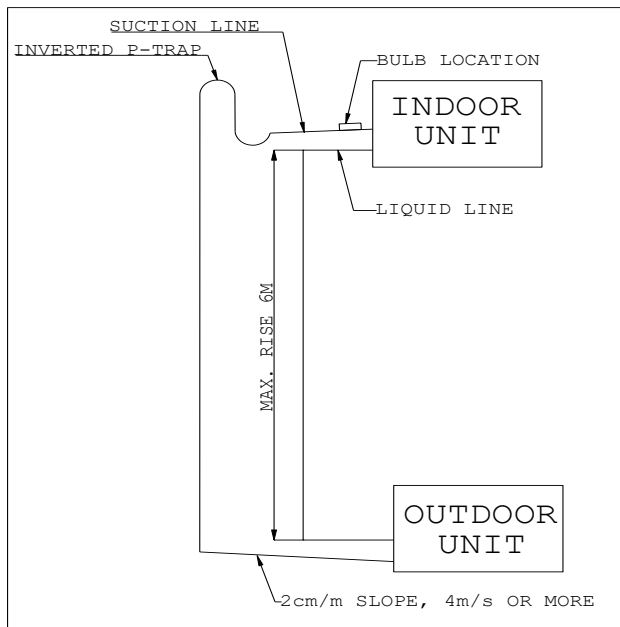


Figure 7: Piping Layout for Outdoor Below Indoor



One of the main factors affecting equipment reliability and compressor service life is refrigeration circuit contamination.

NOTICE

During installation, circuit contamination can be caused by:

- Brazing & Welding Oxides
- Filings & Particles from de-burring pipework
- Brazing Flux
- Moisture & Air

Pressure Testing



Never use oxygen, dry air, or acetylene for pressure testing systems as these may form an inflammable mixture.

CAUTION

- The condensing units are pressure tested in the factory prior to dispatch. All units come with a holding charge of oxygen free nitrogen. Remove the holding charge and indication tag prior to pipework installation using the service valve or regulator with pressure gauges and hoses.
- Once the pipework installation is complete, it should be pressure tested for leak prior to evacuation.
- A pressure leak test should be carried out using oxygen free nitrogen (OFN). A calibrated nitrogen pressure regulator must always be used. Before starting any pressure testing, ensure that the area surrounding the system is safe, inform relevant personnel and fit warning signs indicating high pressure testing. Also, use the correct Personal Protection Equipment (PPE).
- Always pressurize the system slowly, preferably in stages up to the maximum required pressure. Never exceed maximum test pressures shown in **Table 11**. Failure to obey the limit will cause premature failure on the pressure safety device.

Table 11: Test Pressure

High Side, barg (psig)	Low Side, barg (psig)
28 (405)	19 (275)

- Listen for any possible leaks and check all joints with bubble spray. If any leaks are discovered, release pressure slowly from both suction and liquid line of system until empty, repair leak and then repeat pressure testing procedure. Never attempt to repair a leak on a pressurized system.
- A strength test should also be incorporated (to the installed pipework only) according to applicable standards.
- Once testing has been completed satisfactorily, release the pressure from the system gradually and safely to external atmosphere.

Evacuation and Charging



NOTICE

Moisture prevents proper functioning of the compressor and the refrigeration system. Ensure that a good quality vacuum pump is used to pull a minimum vacuum of 250 microns (0.25 torr) measured at refrigeration system, and not at the vacuum pump gauge.

Once pressure testing has been completed, the system can now be evacuated to remove any moisture from the piping. This can be done as follows:

- Ensure any nitrogen charge is safely released from the system.
- Connect a gauge manifold to the connections on the service valves on the condensing unit.
- Connect a vacuum pump and vacuum gauge to the system.
- Ensure all gauge manifold and service valves in open position.
- Evacuate the system until vacuum is below 250 microns (0.25 torr).

Note: A triple evacuation procedure is recommended for all new systems or where moisture is suspected.

- Once the system is isolated and the vacuum pump is switched off, any rise in pressure indicates that either there may be a leak in the system or moisture is still present. In this case, recheck the system for leaks, repair as necessary, and then repeat the evacuation procedure.
- Once evacuation is completed satisfactorily, the vacuum pump and vacuum gauge can be removed. At this point, the refrigerant charge can be added to the system as required. Refrigerant blend must be charged in liquid form to avoid change of chemical properties.
- Ensure an adequate liquid charge (4~5barg) has been introduced to the high side of the system via schrader port of liquid receiver before starting the compressor.
- The remaining charge is slowly throttled into suction side until the installation has reached a level of stable nominal condition during operation. **Charging liquid into the suction side of the system should ONLY be done with a metering device.** Ensure a minimum operating pressure 0.5barg is maintained when add refrigerant to the suction side, otherwise overheating of the scroll may occur. Use calibrated weighing scales to record the amount of refrigerant added to the system.
- Stop the filling once obtain sufficient suction superheat and liquid subcooling, remove the cylinder from circuit.
- Fill the charge amount on the provided refrigerant charge label.



Refrigerant charge by judging the liquid sight glass does not guarantee as 100% correct way.

NOTICE

Electrical



The mains electrical supply to the condensing unit must be via a suitable motor rated circuit breaker or fuse. A mains isolator is fitted to all condensing units therefore an additional isolator is not required unless site conditions

NOTICE

or regulations dictate differently.

J & E Hall Fusion Digital Scroll condensing units require a 400 Volt / 3 phase / 50Hz supply, which must include a Neutral and an Earth. These systems are not suitable for any other supply voltages (other than a deviation of +/- 10% of the above values) and are not suitable for 60Hz supplies.

Below table lists the recommended wiring sizes for the condensing unit power supply cables. These wiring sizes are valid for cable lengths up to 30m.

Table 12: Recommended Cable Size and Fuse

Model	Cable size, mm ² (from network to unit main switch)	Maximum Fuse Rating (A)
JEHSD-0400-B3-M-3	4	20
JEHSD-0600-B3-M-3	4	25
JEHSD-0800-B4-M-3	6	32

Note: Above is just a guideline for wire size. Installer might specify cable size different from this guideline, depending on the wire material and length, system design, ambient temperature, etc.

- Mains supply cable type and sizing must be selected to suit the application and the electrical installation should conform to the current local standards.
- Cables to the condensing unit should, wherever possible, be routed through the cable glands supplied on the rear of the units. Ensure no touching of supply cable to hot surface such as compressor body and discharge pipe.
- Connect the mains supply to the units as per the wiring diagrams.
- Ensure that the power supply corresponds to the unit and that the power supply is stable.
- Connect power supply according to the present norm and legal requirement. Ensure that the unit is properly connected to the ground. And termination of live wire at isolator switch in such a way that the compressor motor rotates in correct direction.
- The unit is equipped with a motor circuit breaker with overload protection for compressor. Overload protection is preset from factory and value can be found on the wiring diagram adhered on the control box cover.
- Ensure mechanical bypass switch is turned to OFF position (0) during normal operation.
- During refrigerant charging for full load condition, compressor capacity modulation is to be bypassed. Change only the mechanical bypass switch to position

(1) when the power is isolated from controller. Failure to do so will trigger alarms and require power supply reset to clear the alarms.

Reverse Rotation Protection and Voltage Unbalance

The condensing unit does not include phase protector; thus, it is necessary to ensure correct compressor rotation and incoming line voltage variance within +/-2% during commissioning.



NOTICE

3 phase digital scroll compressors require proper phase sequence to secure right rotation and therefore compression. The phase sequence must be secured between network and compressor.



CAUTION

Do not use a megohmmeter nor apply power to the compressor while the system under vacuum as this may cause internal damage to the compressor.



CAUTION

Never start the compressor under vacuum (do not operate the compressor with the low-pressure cut-out bypassing), as this will cause the rotating part to overheat very quickly causing premature failure.



NOTICE

There must be no more than 10 compressor's start per hour. A higher number reduces the service life of the compressor. There is no minimum off time for scroll compressors. Adequate minimum run time is required to ensure proper oil return.

Commissioning

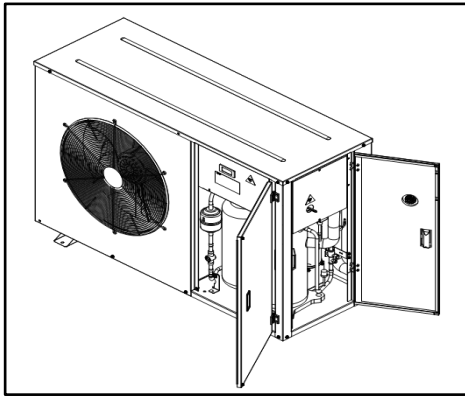
Access to Controller and LCD Display



Warning! Only Authorized personnel are allowed to access the controller and LCD display.

To gain access to the electrical box, turn the mains isolator switch on the side/front of the unit to the OFF position, loosen the screws on the left-hand side of the door and open door. The electrical box is located behind the door. Remove the screws in the electrical box cover to access components.

Figure 8: Access Point



Pre startup checks

Before starting the condensing unit, the following checks should be carried out as a minimum:

- Check electrical supply is correct and all connections are sound.
- All moving parts are free, and guards are fitted.
- Compressor oil level satisfactory.
- Mechanical bypass switch on the control panel is in the **OFF (0)** position.
- LCD display cable is connected to the controller to enable settings.
- Check setting of Low-Pressure Switch (back up control-maintain factory default setting).
- Overload set correctly on motor circuit breaker (maintain factory default setting as shown on wiring diagram).
- All valves are in correct operating position.
- Initial refrigerant charge.
- Crankcase heater had been energized for a minimum of 12 hours before compressor start-up.
- Gauge manifold connected to both low and high sides of system.
- Refer **Page 15-16** to change the required compressor setpoint and the type of refrigerant to suit the application. Else, maintain the factory default setting as shown in **Table 13**.



Please wait approximately 1 minute for controller initialization after switching on the main isolator.

Running the unit

- Switch unit ON at controller (Refer **Page 15**).
- Run the unit and check compressor and condenser fan operation.
- Check system pressures and temperatures, gas charge and running currents of motors to ensure correct operation.
- Check transducer / sensor readings are accurate (calibrated equipment required).
- Check compressor suction superheat. This should be between 10~20K at normal operating conditions.
- Final adjustment of controller settings.
- Allow the system to run for 3 – 4 hours. Check compressor oil level and top up with the correct oil type as required (Refer **Table 1**). Recheck the compressor oil level again after 24 hours operation.
- Carry out final leak test and ensure all panels/covers are fitted and screws tightened.
- Log all information along with the system model and serial numbers for future reference. Complete refrigerant labelling to comply with F-Gas regulations.
- Ensure that the customer / responsible persons are provided with basic operating instructions and where electrical isolators are situated in case of emergency.

Table 13: Factory Default Settings

Description	Factory Default Setting	Remark
Compressor setpoint	4.3barg, neutral zone differential: 0.5barg	Compressor is controlled at setpoint suction pressure. No loading/unloading if work within the range (setpoint ± NZ differential). To change setpoint to suit application.
Condenser Fan Modulation	Setpoint: 16barg, differential: 3barg, Proportional. Cut In only when compressor is turned ON	Fan starts to rotate when compressor is turn ON and discharge pressure more than 13barg. Fan runs at full speed when pressure more than 19barg.
Refrigerant preset on controller	R448A	Type of refrigerant approved for selection: R407A, R407F, R448A, R449A
Low Pressure Switch	Cut In: 3barg, Differential: 2barg (Auto Reset)	To cut off compressor when suction pressure drops below 1.0barg * Software low pressure alarm threshold 1.2barg
High Pressure Switch	Cut Out: 28barg, Auto Reset: 22barg	Cartridge type high pressure switch auto reset once fault is removed, and high side pressure drop below 22barg.
Unit Status On/Off on keyboard	Off position	To switch unit ON/OFF, press PRG button to go Main Menu screen and select "A. On/Off Unit". Using the combination button of ENTER, UP/DOWN arrows to change the unit On/Off status.

User Terminal Interface – LCD Display

The user terminal interface can be used to perform all the operations allowed by the program, display the operating conditions of the unit all the time, and set the parameters. It can be disconnected from the main board, and in fact is not required for operation.

Figure 9: LCD Display



Table 14: LCD Display Button Functions

ALARM	Displays the alarms. Press around 2 seconds to reset the alarm manually after the fault is removed.
UP	If the cursor is in the home position (top left corner), scrolls up the screens in the same group; if the cursor is in a setting field, and increases the value.
DOWN	If the cursor is in the home position (top left corner), scrolls down the screens in the same group; if the cursor is in a setting field, and decreases the value.
ENTER	Used to move the cursor from the home position (top left corner) to the setting fields, in the setting fields confirms the set value and moves to the next parameter.
PRG	Accesses the menu for selecting the group of parameters to be displayed/modified (access to the parameters is confirmed by pressing the [Enter] button).
ESC	Used to move back to previous screen/sub-menu. Continuous pressing of the ESC button will eventually return to the HOME screen.



NOTICE

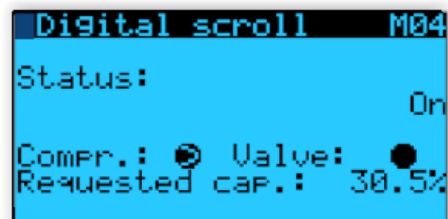
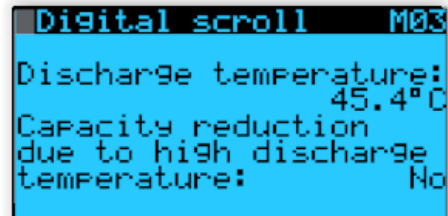
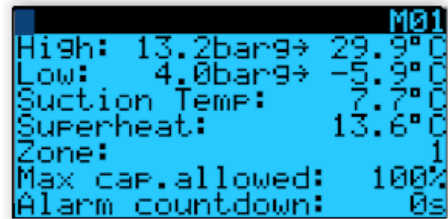
All controller parameters are preset in the factory and are password protected. The only settings which can be changed are the compressor setpoint (suction pressure), the refrigerant type and the time/date. The fan setpoint is also preset but can be adjusted if required.

Controller Home Screen

Following controller power-up and initialisation process (approximately 1 minute), the controller home screen will appear as follows:

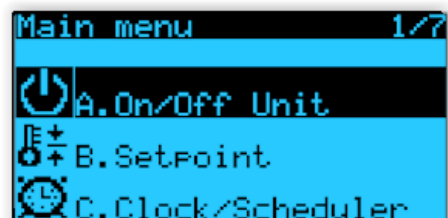
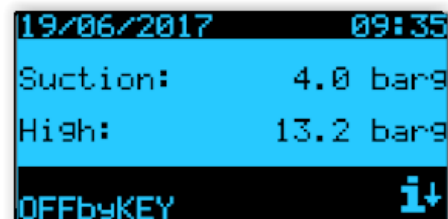


The low and high-sides conditions of the unit are displayed on screen M01. Further information on the system conditions can be displayed by pressing the DOWN arrow:

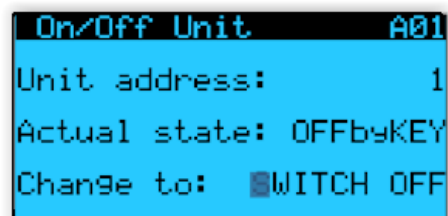


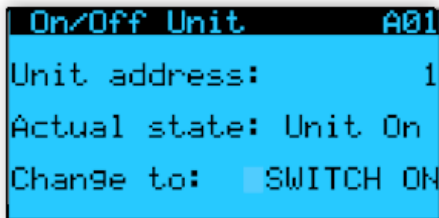
Switch Unit ON / OFF (By Controller)

1. With controller home screen displayed, if **OFF by Key** is indicated in the lower box, it shows that the unit is switched OFF by the controller. To switch the unit ON, follow instructions below. Press PRG button to go Main Menu screen and select "A. On/Off Unit".



Press ENTER button to access to mask A01. Switch Unit ON by using UP/DOWN arrows. Press ENTER button to confirm.





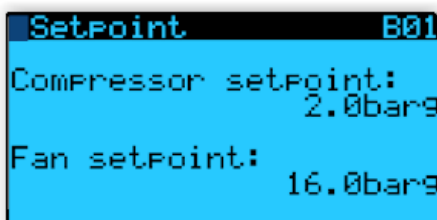
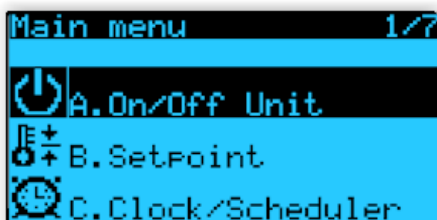
2. Press ESC button repeatedly to return to Home Screen. This should now show ON by KEY at the bottom of the screen.
3. The unit will start up following a short delay (assuming all conditions for compressor start-up are met).

Changing Set Point and Refrigerant Selection

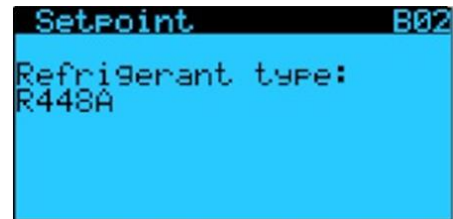


The only refrigerants which should be selected are R407A, R407F, R448A & R449A. Setpoint only could be altered with the unit OFF by Key.

1. With controller Home screen displayed **OFF by Key**, Press PRG button to go Main Menu screen and select "B. Setpoint" using DOWN button. Press ENTER button to access to mask B01.



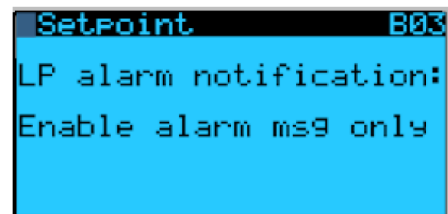
2. Using ENTER button, move the cursor from the 'home' position to the **Compressor Setpoint** and adjust value as required by using UP or DOWN buttons.
3. Press the ENTER button again to move the cursor to the **Fan Setpoint** and adjust the value as required. **Please note that the setpoint value of 16.0 bar is recommended for R407A/R407F/R448A/R449A operation.**
4. Press ENTER button once more to return the cursor to the 'home' position.
5. From mask B01, use the DOWN button to move to the next, mask B02.



6. At mask B02, the Refrigerant Type can be selected. The default refrigerant is set as R448A.
7. To change the refrigerant, press ENTER to move the cursor from the 'home' position to the refrigerant type.
8. Use UP or DOWN buttons to scroll to different refrigerants.
9. With the required refrigerant selected, press ENTER button to confirm and return cursor to 'home' position.
10. Press ESC button repeatedly to return to Home screen.
11. The unit is now ready to run once the controller is set to ON.

Altering Low Pressure Alarm Notification Setting (Optional)




1. With controller Home screen displayed, Press PRG button to go Main Menu screen and select "B.Setpoint".
2. Press ENTER button and follow with down button till mask B03 is displayed.



3. Press ENTER button to move cursor from 'home' position to the selection. Select the desired low pressure alarm notification setting by UP/DOWN arrows. Three types of LP alarm notification setting are available:
 - i. Enable alarm msg only (by default)
 - ii. Disable all
 - iii. Enable all
4. With the required LP alarm notification setting selected, press ENTER button to confirm.
5. Press ESC button repeatedly to return to Home Screen.
6. The unit is now ready to run once the controller is set to ON.

The action for each low-pressure alarm notification setting when system pressure is lower than the threshold of the low-pressure transducer/switch is shown in **Table 15**.

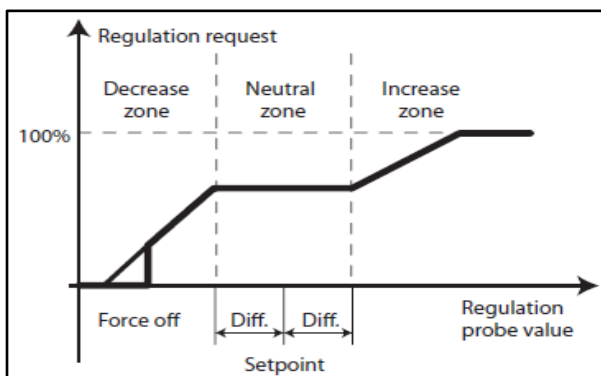
Table 15: Low Pressure Notification Alarm

Notification Setting	Controller Display	Actions
Enable alarm msg only	<ul style="list-style-type: none"> Alarm code and warning symbol  are displayed. Event log is recorded 	K4R Alarm relay will NOT be activated
Disable all	<ul style="list-style-type: none"> Alarm code and warning symbol  are NOT displayed. Event log is recorded 	K4R Alarm relay will NOT be activated
Enable all	<ul style="list-style-type: none"> Alarm code and warning symbol  are displayed. Event log is recorded 	K4R Alarm relay will be activated after pre-set time delay (300s)

Compressor Operation for Capacity Regulation

At initial start-up, the digital compressor will run at 50% capacity for 3 minutes followed by 100% capacity for 1 minute. Following this, the compressor (capacity) will be regulated in relation to the suction pressure as shown in Figure 10.

Figure 10: Regulation Request Versus Setpoint



When the suction pressure falls inside the neutral zone (setpoint +/- differential), the capacity is stable and there is no loading or unloading of the digital scroll compressor.

Once the suction pressure falls outside the neutral zone, the capacity request decreases or increases, depends on the deviation from the setpoint. (Figure 10).

The default settings for pressure differentials in neutral, activation and deactivation zone as below (Fdc05).

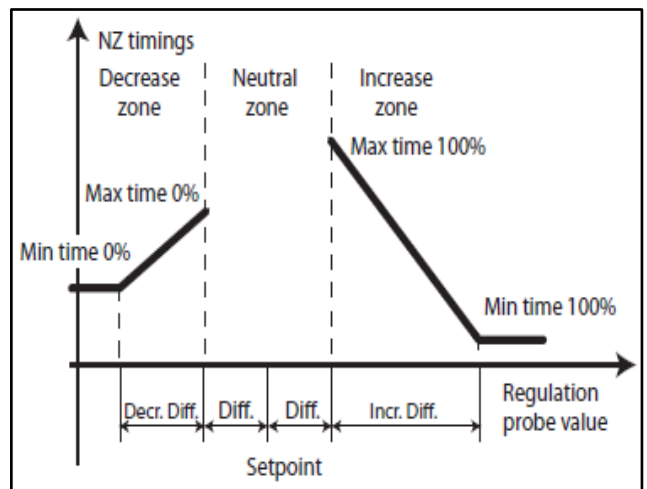
```

Compressor Fdc05
Neutral zone conf19
NZ diff.: 0.5bar9
Activ.diff.: 1.2bar9
Deact.diff.: 1.2bar9
    
```

The rate at which the capacity decreases or increases depends on the times defaulted in masks Fdc07, Fdc08 and Fdc09. This means that the further away the suction pressure moves away from the Neutral Zone (either above or below), the quicker the controller will adjust the compressor capacity (Figure 11).

The minimum times represent the time needed to change the capacity.

Figure 11: Neutral Zone Timings Versus Setpoint



Time control parameters for compressor regulation in Figure 11 are defaulted in Fdc07, Fdc08 and Fdc09.

```

Compressor Fdc07
Neutral zone
Load min.time: 120s
Load max.time: 600s
    
```

```

Compressor Fdc08
Neutral zone
Unload min.time: 120s
Unload max.time: 600s
    
```

```

Compressors Fdc09
Load up time: 10s
Load down time: 10s
    
```



NOTICE

None of the above settings can be altered.

The default cycle for pulse width modulation is 20seconds. When the required capacity is 10%, the compressor will be loading for 2s and unloading for 18s. This is managed by the compressor solenoid valve opening and closing time.

Pressure Switches Settings (Mechanical)

The Saginomiya SNS low pressure switch fitted to the JEH Digital Scroll condensing unit has **adjustable cut-out** and differential. High pressure protection is provided by a non-adjustable cartridge type high pressure switch.

High Pressure Safety Switch

The high-pressure safety switch is required to stop the compressor should the discharge pressure exceed the values shown in **Table 16**. The differential pressure is fixed at 6 bar (87 psi). Once tripped, it will create an alarm condition which requires manual reset at the controller.

Low Pressure Protection Switch

The adjustable low-pressure switch provides compressor protection from low suction pressure/evaporating temperature in Normal (controller) operation. In mechanical bypass mode, it provides compressor control and protects the compressor against deep vacuum operation, a potential cause of failure due to internal arcing and overheating. The low-pressure switch is factory set as **Table 16** for Normal (controller) operation.



NOTICE

If the Low-Pressure Switch was adjusted for operation in bypass mode, it must be reset back to factory setting as below before returning to Normal (controller) operation.

Table 16: Low- and High-Pressure Switch Settings

Refrigerant	Low Pressure, barg (Auto Reset)			High Pressure, barg (Auto Reset)	
	Min. Cut Out	Factory Default		Cut in	Cut Out
		Cut in	Differential		
R407A/R407F/R448A/ R449A	1	3	2	22	28

AC Fan Speed Modulation

Only one of the condensing fans is controlled by a phase cut modulating device based on discharge pressure and is configured to run only when compressor is run.

The fan under FSC control will start at 100% speed for approximately 5 seconds before starting to modulate as shown in **Figure 12**.

Fan control automatically switched to be controlled by external air temperature probe if fault discharge pressure transducer.

The default setting for fan speed control and the recommended settings to gain higher energy efficiency as published in the Eco-design data sheets are shown in **Table 17**.

Figure 12: Fan Control Curve

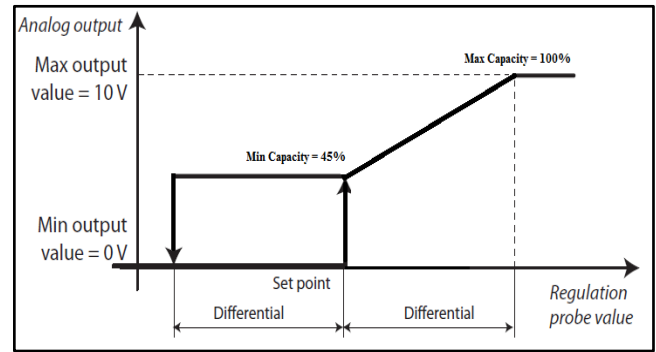
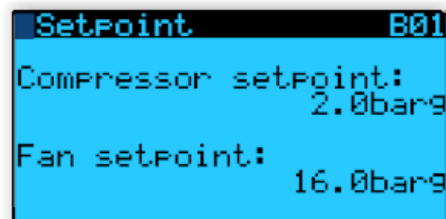


Table 17: Fan Speed Controller Settings

Refrigerant	R407A/R407F/R448A/ R449A	
Rated Condition	Performance Data (Default)	Eco-design Data
Condenser Fan (Fdc28)	Cut off enable: No	
Fan setpoint limit (Fdc16)	Minimum: 12.0barg Maximum: 28.0barg	Minimum: 8.0barg Maximum: 28.0barg
Setpoint (B01)	Fan setpoint: 16barg	Fan setpoint: 13.5barg
Regulation (Fdc11)	Differential: 3barg Dead band: 0.0barg	Differential: 5.5barg Dead band: 0.0barg

Fan setpoint could be changed via mask B01.



Manual Bypass Operation

In the event of failure of the main electronic controller, the unit can be run temporarily in mechanical bypass mode.

To turn to bypass mode, turn off the power supply to the unit, then change the position of the manual bypass switch mounted on the electrical box from '0' to '1'.

In bypass mode, the compressor and condenser fan will always run at full capacity. The compressor activation is solely controlled by the adjustable LP switch.



WARNING

Ensure the bypass switch is always at "0" position while running in electronic controller mode.

Alarm Information

The controller does protect the compressor from operating outside the unit's operating envelope. The defaulted high and low pressure/temperature alarms are shown in **Table 18**.

Example: When the low pressure falls below threshold value of 1.2barg, low pressure alarms will be triggered after countdown 10s. The compressor will auto restart after the suction pressure rise above the low-pressure switch cut in value: 3barg.

Table 18: Alarm Default Settings

Mask	Parameter	Settings
Fdc17	Low pressure alarm	
	Threshold (barg)	1.2
	Differential (barg)	0.8
Fdc18	Low pressure alarm	
	Startup delay (s)	10
	Running delay (s)	0
Fdc20	High pressure alarm	
	Threshold (barg)	28
	Differential (barg)	7
Fdc21	High condensing coil temp alarm	
	Threshold (°C)	60
	Delay time (s)	20

When the unit is triggered off by alarm, the alarm LED will be steady ON or blinking. To view the error, press button ALARM, ENTER and UP/DOWN to access alarm log history. Clear the fault accordingly before manual restart.

Table 19: Error Code

Code	Description	Reset type
A01	Clock board error	Auto
A08	Suction temperature probe fault	Auto
A09	Outdoor temperature probe fault	Auto
A10	Condensing coil temperature probe fault	Auto
A11	Discharge temperature probe fault	Auto
A13	Discharge pressure transducer fault	Auto
A14	Suction pressure transducer fault	Auto
A15	Outside of operating envelope (Digital scroll)	Auto
A16	Condensing coil high temperature	Auto
A17	Compressor high discharge temperature alarm	Auto
A19	Compressor overload trip	Auto
A24	Low pressure alarm by transducer	Auto
A25	High pressure alarm by transducer	Auto: less than 3 times in 30 minutes Manual: 3 times or more in 30 minutes
A26	Low pressure alarm by pressure switch	Auto
A27	Compressor high pressure alarm by pressure switch	Manual

Table 20: LCD Display - Alarm Status

LED	Alarm	Require Action
Steady On	Not active	Auto or manual reset
Blinking	Active	Manual reset

- **Auto reset:** An alarm condition is created but when cleared, the unit will restart automatically.
- **Manual reset:** An alarm condition is created and requires resetting manually before the unit can restart.
- **To reset alarm:** Press button ALARM on the LCD display for a few seconds.

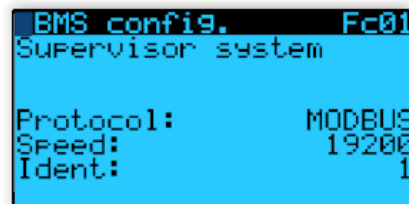
BACnet and Modbus Protocol

To enable BACnet or Modbus Protocol feature, an additional serial card and its' bracket (which need to be separately ordered) need to be fixed into the board.

Table 21: Serial Cards for Different Protocol

Protocol	Description
Modbus RTU	Optocoupled RS485 Serial Board (PCOS004850)
Modbus RTU Serial Card Bracket	Support for RS485 serial interface (PCOS00S030)
Bacnet MSTP	PCONET SE, RS485 card BACNET MS/TP PCO1000BD0)
Bacnet IP	PCOWEB SE, ethernet card IP (PCO1000WD0)
Bacnet IP/MSTP Serial Card Bracket	Bracket serial card PCO-WEB(PCOS00S010)

After plug in the serial card, it is required to configure the corresponding type of serial card in mask Fc01.



Please contact J & E Hall for the BMS point list for Modbus and BACnet protocol.

Service & Maintenance



Warning! – Disconnect the mains electrical supply before servicing or opening the unit.

The condensing units are designed to give long life operation with minimum maintenance. However, they should be routinely checked, and the following service schedule is recommended under normal circumstances.

1. Compressor – Inspect at regular intervals.

- Check for refrigerant leaks on all joints and fittings.
- Check mountings for tightness and wear.
- Check operation of crankcase heater.
- Check electrical connections.
- Ensure that no abnormal noise or vibration is detected during the test run.
- Check the compressor oil levels and top up if required. The oil level should be $\frac{1}{2}$ to $\frac{3}{4}$ way up the sight glass (where fitted).

2. Condenser Fan Motor & Blade – Clean and inspect at regular intervals.

- Check for abnormal noise, vibration, and fan imbalance.
- Ensure that the fan motor is clean and spins freely.
- Check that the condenser fan blade is clean and free from restriction and damage/imbalance.

Note: The fan motor is pre-lubricated, and factory sealed so no maintenance is necessary.

3. Condenser Coil – Clean and inspect at regular intervals.

- Check and remove the dirt and debris between the fins using a soft brush, low pressure compressed air/inert gas or a low-pressure sprayer utilizing clean water. A suitable chemical coil cleaner may be used as required. Accumulations of dirt on the condenser face can be removed with a soft bristle hand brush. When using liquids, ensure electrical items are isolated and correctly protected.
- Check and remove any obstacles which may hinder the airflow through the condenser coil.

Note: Do not use high pressure jet washer to clean the condenser coil.

4. Controls

- Check low pressure switch settings and controller settings (refer **Table 13**).
- Check overload setting on motor rated circuit breaker.

5. Power Supply – Inspect at regular intervals.

- Check the running current and voltage for the condensing unit.
- Check the electrical wiring and tighten the wires onto the terminal blocks if necessary.

6. Refrigerant Charge

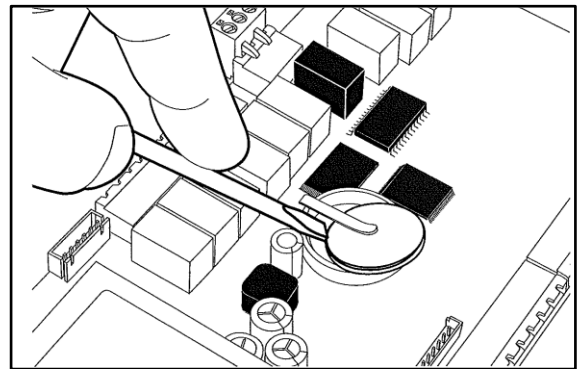
- Check the refrigerant charge by ensuring that the system is operating correctly, the pressures are as expected and that the liquid line sight glass shows a full bore of liquid refrigerant.
- Carry out a full leak test.

7. Compressor replacement (rotalock connections)

- The rotalock connections used on some compressor models are factory sealed with Loctite 554 thread sealant. If the rotalock connections need to be disassembled (e.g., compressor change), then they should be thoroughly cleaned and Loctite 554 reapplied before reassembly. In case of difficulty undoing the connections due to the sealant, apply heat to rotalock using a heat gun for several minutes and then loosen using hand tools whilst hot. Replacement of the 'O' ring seal may be required. Refer **Table 24** for recommended torque tightening values.

8. Unit decommissioning and disposal

- At the end of the unit's useful life, a suitably qualified engineer should decommission it. The refrigerant and compressor oil are classed as hazardous waste and as such must be reclaimed and disposed of in the correct manner, including completion of waste transfer paperwork. The unit components must be disposed of or recycled as appropriate in the correct manner.
- Do not dispose of the small version controller as municipal waste, it must be disposed of through specialist waste disposal centers. It contains a battery that must be removed and separated from the rest of the product according to the instructions provided, before disposing of the product. Improper use or incorrect disposal of the product may have a negative effect on human health and on the environment. The public or private waste collection systems defined by local legislation must be used for disposal.
- In the event of illegal disposal of electrical and electronic waste, the penalties are specified by the local waste disposal legislation.



The battery in the controller should be changed every three years.

9. Warranty

- The warranty as provided by J & E Hall on its products is subject to correct application, siting, and installation procedures together with subsequent recorded maintenance/servicing carried out in accordance with our recommendations. Failure to do so could result in the withdrawal of our warranty.

Please go to our website for our detailed warranty terms and conditions: www.jehall.co.uk

F-Gas Requirement

- The models of equipment covered in this Technical Manual rely on fluorinated greenhouse gases for their functioning.
- All unit models come from the factory pressurized with OFN (Oxygen Free Nitrogen) only.
- In F-Gas Regulation EU 517/2014, the requirement for leak testing on the system is based on the charge size in tonnes of CO₂ equivalent. Which means systems with higher GWP refrigerants will need to be leak tested more frequently than those with the same charge weight of a lower GWP refrigerant.
- The GWP (Global Warming Potential) values of refrigerants which are specified for use along with the three new thresholds for leak testing requirements based on TCO₂Eq (Tonnes CO₂ Equivalent) are as follows:

Table 22: Tonnes CO₂ Equivalent

Refrigerant	GWP	Refrigerant Charge - kg		
		5T CO ₂ Eq	50T CO ₂ Eq	500T CO ₂ Eq
R407A	2107	2.4	23.7	237
R407F	1825	2.7	27.4	274
R448A	1387	3.6	36.0	360
R449A	1397	3.6	35.8	358

Starting 1st January 2017, the requirement for leak detection and maintaining system logs changes from 3kg HFC to 5TCO₂Eq.

Table 23: Leak Inspection Frequency

System Charge (TCO ₂ eq)	Leak Inspection Frequency
e.g. 3.6 to 36 kg R448A	<ul style="list-style-type: none"> • At least once every year.
5 to < 50	<ul style="list-style-type: none"> • At least once every 2 years if a fixed leak detection system is fitted.

A refrigerant charge label is supplied with each unit (inside the electrical box). The total refrigerant charge for the system and the TCO₂Eq value must be entered on the label with indelible ink and must be adhered in the proximity of the product charging port. The label supplied will represent the refrigerants approved for use with that unit. An example of the unit label is as follows.

Use below formula to calculate the value of TCO₂Eq.

$$TCO_2 \text{ Eq value} = \frac{\text{Refrigerant Charge (kgs)} \times \text{Refrigerant GWP}}{1000}$$

Contains fluorinated greenhouse gases			
Ref.	GWP	Charge (kg)	TCO ₂ Eq.
R407A	2107		
R407F	1825		
R448A	1387		
R449A	1397		

Appendix

Table 24: Tightening Torque

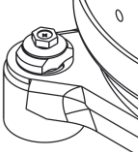
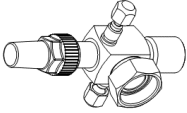
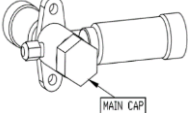
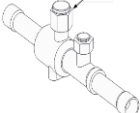
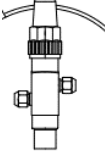
Model	Tightening Torque (Nm)					
	Compressor Mounting	Compressor Rotalock Connection	Main Cap Service Valves	Main Cap Ball Valve	Liquid Receiver	Schrader Valve; Charging port
JEHSD-0400-B3-M-3	M8 (13 Nm)	N/A	Suction: M33*1.5mm (42-47 Nm) Liquid: M18*1.0mm (25-30 Nm)	M16*1.0mm (10-15 Nm)	Brazed Connection	7/16" - 20UNF (14-16 Nm)
JEHSD-0600-B3-M-3		N/A	Suction: M38*1.5mm (42-47 Nm) Liquid: M25*1.0mm (42-47 Nm)	N/A	Plug 3/8"NPT (18-22 Nm)	
JEHSD-0800-B4-M-3		Suction: 1-1/4-12UNF (110-135 Nm) Discharge: 1-1/4-12UNF (110-135 Nm)				
Graphic Presentation						N/A

Figure 13: Outline Dimension JEHS-0400-B3-M-3, JEHS-0600-B3-M-3

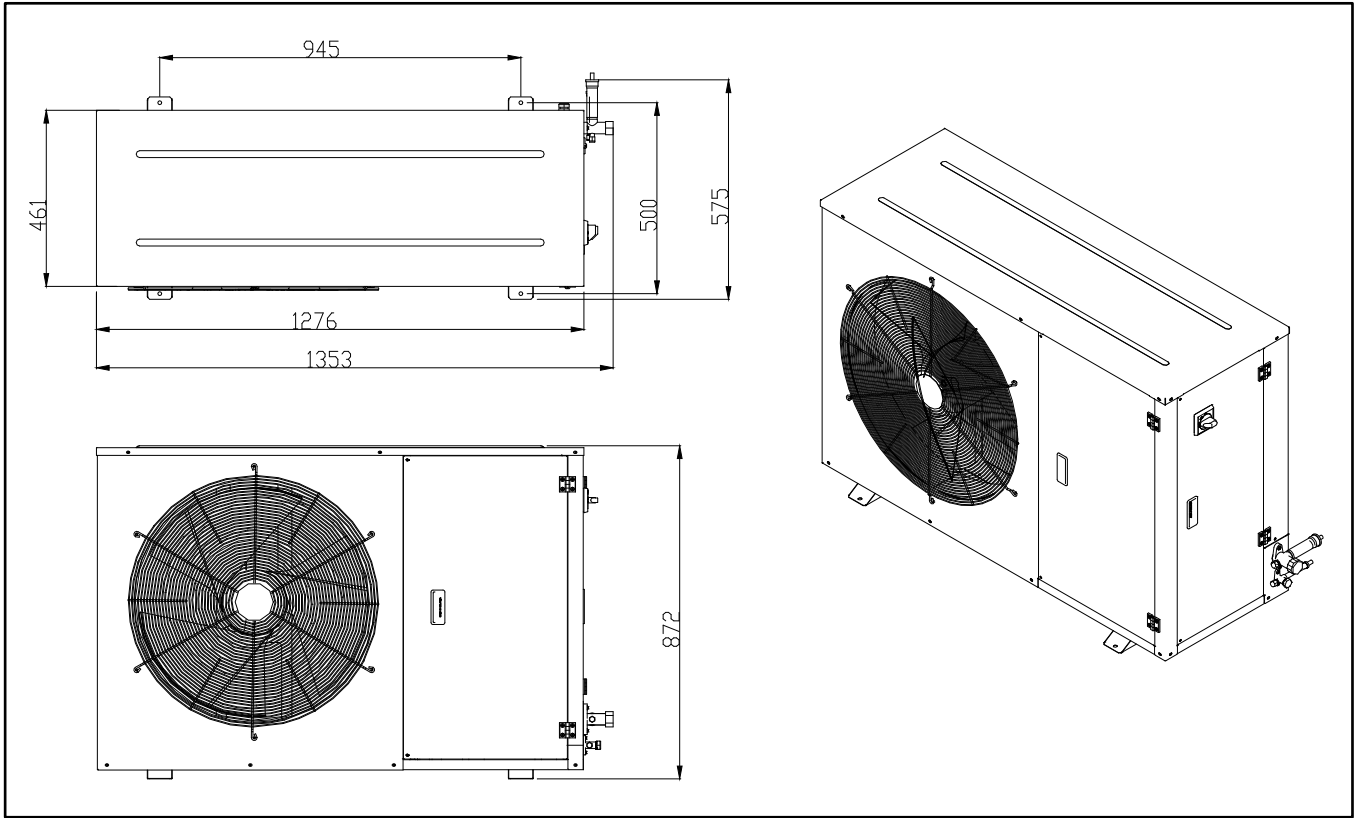


Figure 14: Outline Dimension JEHS-0800-B4-M-3

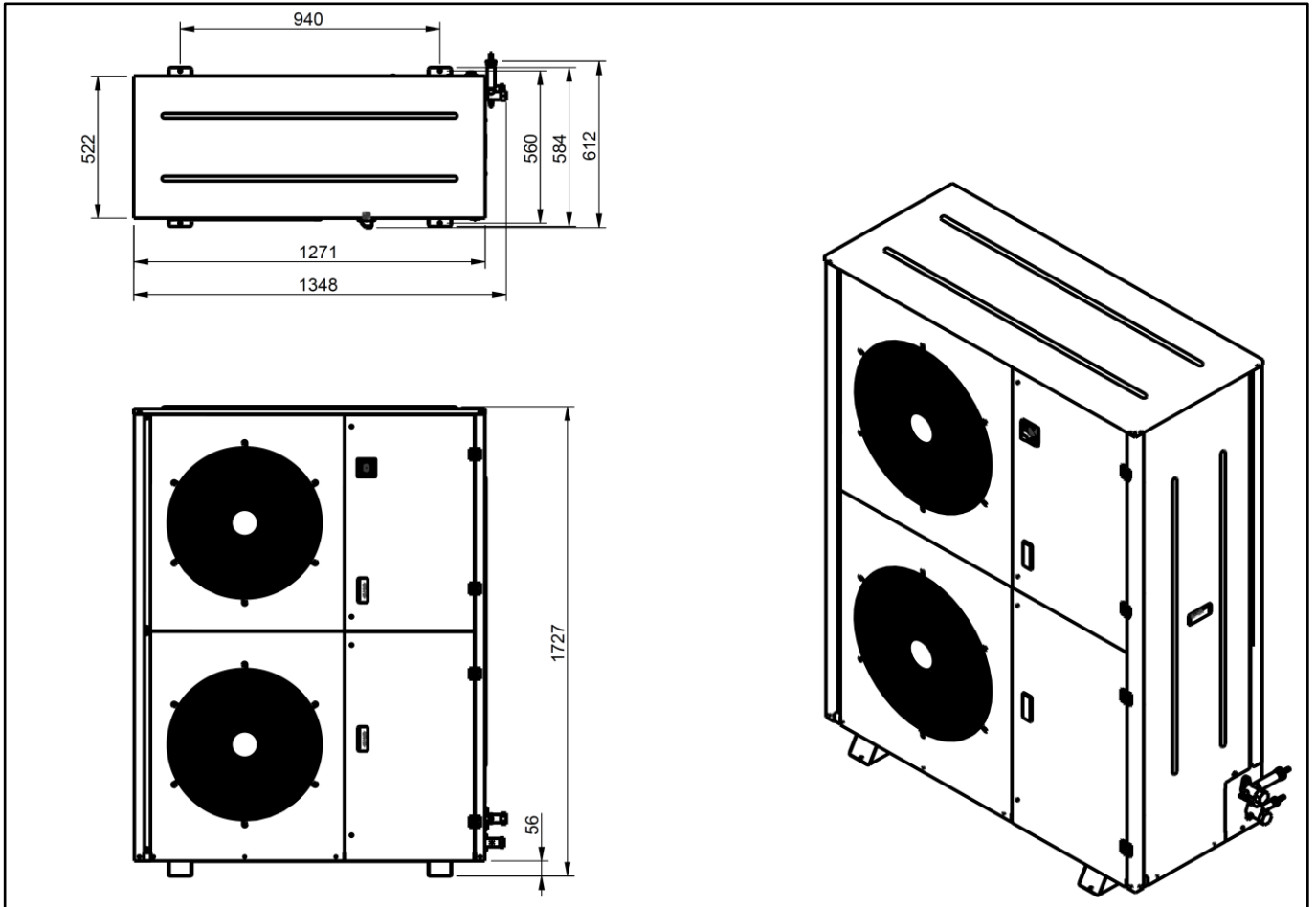


Figure 15: Wiring Diagram JEHS-0400-B3-M-3, JEHS-0600-B3-M-3

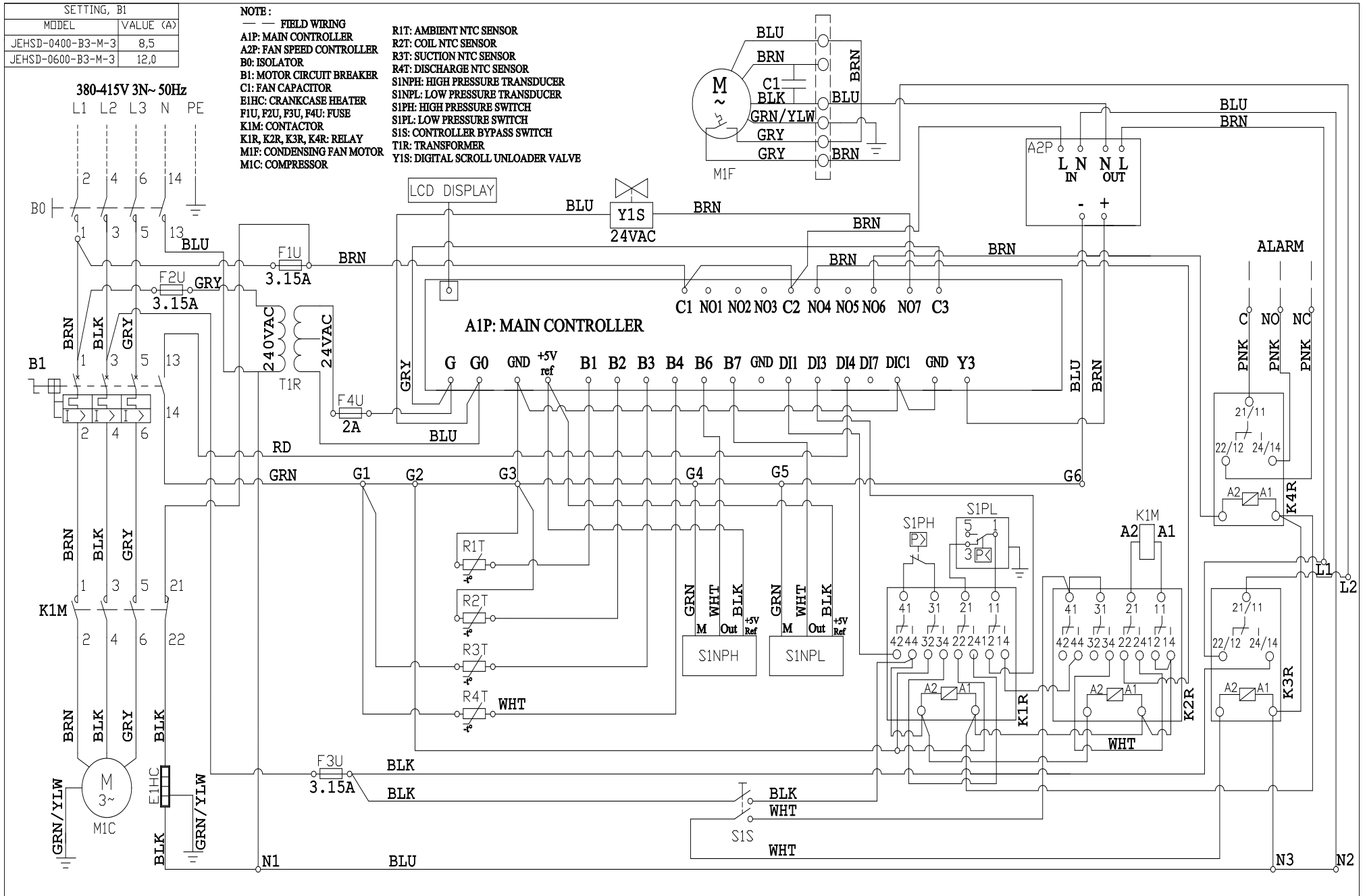


Figure 16: Wiring Diagram JEHS-0800-B4-M-3

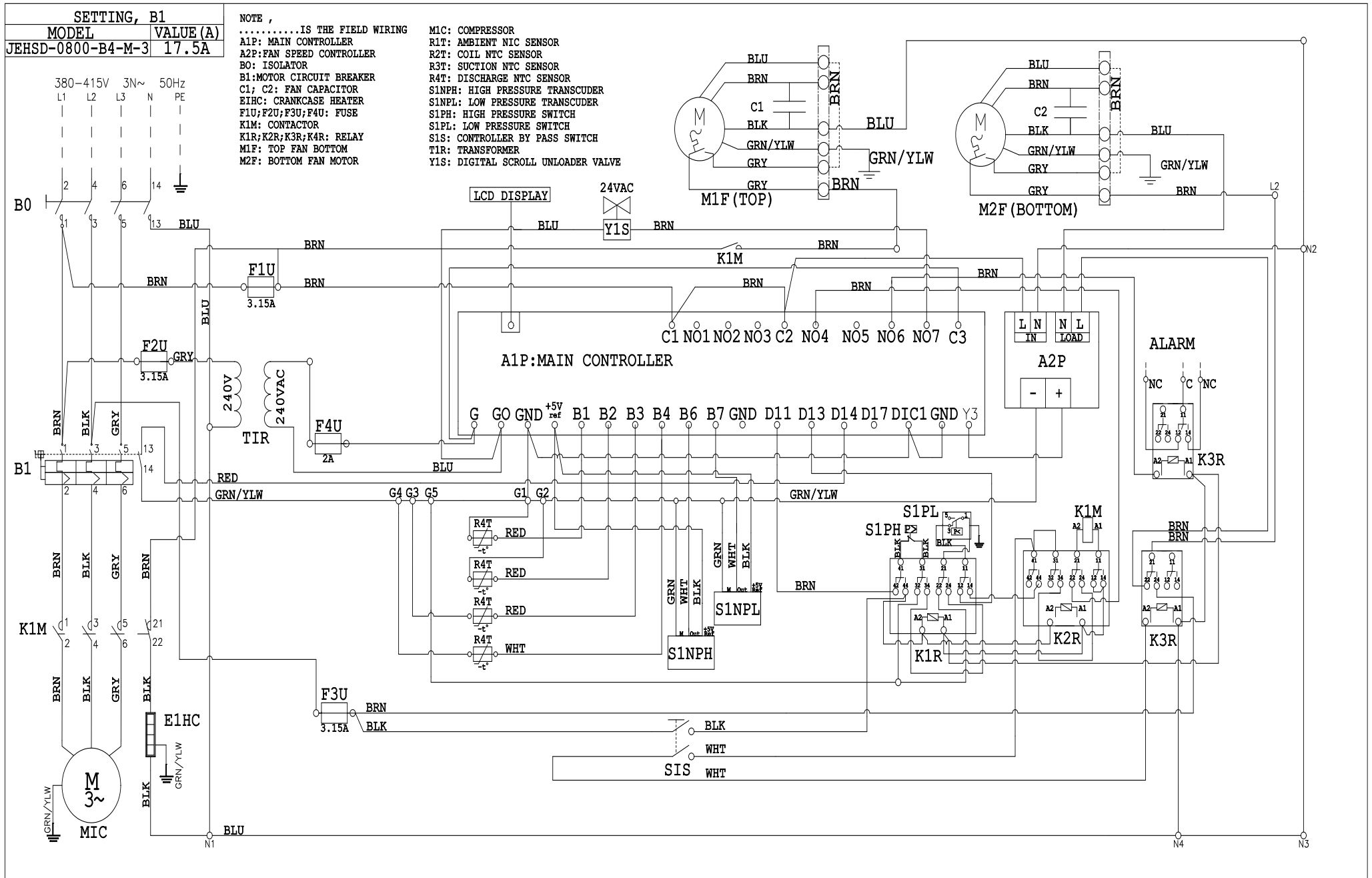


Figure 17: Declaration of Conformity



Declaration of Conformity

According to SI 2016 No. 1105 SCHEDULE 11, SI 2010 No. 2617 SCHEDULE 1

We: J & E Hall International
of: Questor House, 191 Hawley Road, Dartford, Kent, DA1 1PU
Declare under sole responsibility that
The Product: Refrigeration Condensing Unit
Model Designations: JEHS-D-0400-B3-M-3 JEHS-D-0600-B3-M-3 JEHS-D-0800-B4-M-3
Description: Commercial Condensing Units Variable Capacity for Medium Temperature Applications
SI 2016 No. 1105 Conformity Assessment Procedure Followed: Module A2

Description of the pressure equipment constituting the assembly:

Part description	Conformity assessment followed
High pressure switch	Module B + D
Liquid receiver	Module H1
Oil separator	Module H1
Filter drier	SEP
Condenser	SEP
Sight glass & Valves	SEP
Flexible hose, System piping & Pressure accessories	SEP

The object of the declaration described above is in conformity with the following statutory requirements and implementing measures:

SI 2016 No. 1105	The Pressure Equipment (Safety) Regulations
Commission Regulation (EU) 2015/1095	Commission Regulation (EU) 2015/1095 of 5 May 2015 implementing Directive 2009/125/EC of the European Parliament and of the Council with regard to ecodesign requirements for professional refrigerated storage cabinets, blast cabinets, condensing units and process chillers

It has been designed and manufactured to the following designated standards and technical specifications:

BS EN 60335-1	Household and similar electrical appliances. Safety. General requirements
BS EN 60335-2-89	Household and similar electrical appliances. Safety. Particular requirements for commercial refrigerating appliances with an incorporated or remote refrigerant unit or compressor
BS EN 13215	Condensing units for refrigeration. Rating conditions, tolerances and presentation of manufacturer's performance data
DG-0001	Pressure Equipment

SI 2016 No. 1105 conformity assessment was carried out by Hartford Steam Boiler UK (Approved Body Number: 2561), 9th Floor, Chancery Place, 50 Brown Street, Manchester M2 2JT, United Kingdom with Marking Permission HSB UK-22-09-004 issued.

Signed: 
Name: Andrew Bowden
Position: Managing Director
Location: J & E Hall Limited, Questor House, 191 Hawley Road, Dartford, Kent, DA1 1PU
Date: 29/09/2022

Figure 18: Declaration of Incorporation

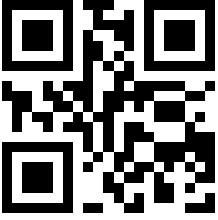
Declaration of Incorporation			
According to SI 2008 No. 1597 Annex II			
We:	J & E Hall International		
of:	Questor House, 191 Hawley Road, Dartford, Kent, DA1 1PU		
Declare that for below			
Product	Refrigeration Condensing Unit		
Model Designations	JEHSD-0400-B3-M-3 JEHSD-0600-B3-M-3 JEHSD-0800-B4-M-3		
Description:	Commercial Condensing Units Variable Capacity for Medium Temperature Applications		
The following essential health and safety requirements of The Supply of Machinery (Safety) Regulations 2008 (SI 2008 No. 1597) are applied and fulfilled:			
1.1.1 – 1.1.2 – 1.1.3 – 1.1.5 – 1.2.1 - 1.2.6 - 1.3.2 – 1.3.3 – 1.3.4 – 1.3.7 – 1.3.8.2 – 1.4.1 – 1.4.2.1 – 1.5.1 – 1.5.2 – 1.5.13 – 1.7.1.1 – 1.7.2 – 1.7.3 – 1.7.4			
The relevant technical documentation has been compiled in accordance with Annex VII (PART 7 of SCHEDULE 2) part B of SI 2008 No. 1597.			
The partly completed machinery is also in conformity with below enactments:			
SI 2016 No. 1105	The Pressure Equipment (Safety) Regulations		
Commission Regulation (EU) 2015/1095	Commission Regulation (EU) 2015/1095 of 5 May 2015 implementing Directive 2009/125/EC of the European Parliament and of the Council with regard to eco-design requirements for professional refrigerated storage cabinets, blast cabinets, condensing units and process chillers		
The relevant information can be transmitted in electronic form in response to a reasoned request by the national authorities.			
The partly completed machinery must not be put into service until the final machinery into which it is to be incorporated has been declared in conformity with the provisions of these Regulations, where appropriate.			
The legal representative authorised to compile the relevant technical documentation is J & E Hall Limited, Questor House, 191 Hawley Road, Dartford, Kent, United Kingdom, DA1 1PU.			
Signed:			
Name:	Andrew Bowden		
Position:	Managing Director		
Location:	J & E Hall Limited, Questor House, 191 Hawley Road, Dartford, Kent, DA1 1PU		
Date:	29/09/2022		
<hr/>			
Form: JEH-C6-016d-01	Questor House, 191 Hawley Road, Dartford, Kent, DA1 1PU	Page 1 of 1	

Figure 19: EU Declaration of Conformity

<p>EU Declaration of Conformity</p> <p>According to DIRECTIVE 2014/68/EU ANNEX IV, DIRECTIVE 2009/125/EC ANNEX VI</p>		
We:	J & E Hall International	
of:	Questor House, 191 Hawley Road, Dartford, Kent, DA1 1PU	
Declare under sole responsibility that		
The Product:	Refrigeration Condensing Unit	
Model Designations	JEHSD-0400-B3-M-3 JEHSD-0600-B3-M-3 JEHSD-0800-B4-M-3	
Description:	Commercial Condensing Units Variable Capacity for Medium Temperature Applications	
DIRECTIVE 2014/68/EU Conformity Assessment Procedure Followed:	Module A2	
Description of the pressure equipment constituting the assembly:		
	Part description	Conformity assessment followed
	High pressure switch	Module B + D
	Liquid receiver	Module H1
	Oil separator	Module H1
	Filter drier	SEP
	Condenser	SEP
	Sight glass & Valves	SEP
	Flexible hose, System piping & Pressure accessories	SEP
The object of the declaration described above is in conformity with the following Union harmonisation legislation:		
DIRECTIVE 2014/68/EU	On the harmonisation of the laws of the Member States relating to the making available on the market of pressure equipment	
Commission Regulation (EU) 2015/1095	Commission Regulation (EU) 2015/1095 of 5 May 2015 implementing Directive 2009/125/EC of the European Parliament and of the Council with regard to ecodesign requirements for professional refrigerated storage cabinets, blast cabinets, condensing units and process chillers	
It has been designed and manufactured to the following harmonised standards and technical specifications:		
BS EN 60335-1	Household and similar electrical appliances. Safety. General requirements	
BS EN 60335-2-89	Household and similar electrical appliances. Safety. Particular requirements for commercial refrigerating appliances with an incorporated or remote refrigerant unit or compressor	
BS EN 13215	Condensing units for refrigeration. Rating conditions, tolerances and presentation of manufacturer's performance data	
DG-0001	Pressure Equipment	
<p>DIRECTIVE 2014/68/EU conformity assessment was carried out by Hartford Steam Boiler UK (Notified Body number: 2833) 28 Windsor Place, Lower Pembroke Street, Dublin 2, Ireland with Marking Permission HSB IE 22-09-003 issued.</p>		
Signed:		
Name:	Andrew Bowden	
Position:	Managing Director	
Location:	J & E Hall Limited, Questor House, 191 Hawley Road, Dartford, Kent, DA1 1PU	
Date:	29/09/2022	
<hr/>		
Form: JEH-C6-017e-01	Questor House, 191 Hawley Road, Dartford, Kent, DA1 1PU	Page 1 of 1

Figure 20: EU Declaration of Incorporation

Declaration of Incorporation			
According to DIRECTIVE 2006/42/EC Annex II			
We:	J & E Hall International		
of:	Questor House, 191 Hawley Road, Dartford, Kent, DA1 1PU		
Declare that for below			
Product	Refrigeration Condensing Unit		
Model Designations	JEHSD-0400-B3-M-3	JEHSD-0600-B3-M-3	JEHSD-0800-B4-M-3
Description:	Commercial Condensing Units Variable Capacity for Medium Temperature Applications		
The following essential health and safety requirements of the Machinery Directive (DIRECTIVE 2006/42/EC) are applied and fulfilled:			
1.1.1 – 1.1.2 – 1.1.3 – 1.1.5 – 1.2.1 – 1.2.6 – 1.3.2 – 1.3.3 – 1.3.4 – 1.3.7 – 1.3.8.2 – 1.4.1 – 1.4.2.1 – 1.5.1 – 1.5.2 – 1.5.13 – 1.7.1.1 – 1.7.2 – 1.7.3 – 1.7.4			
The relevant technical documentation has been compiled in accordance with part B of Annex VI of DIRECTIVE 2006/42/EC.			
The partly completed machinery is also in conformity with below Directives and Regulations:			
DIRECTIVE 2014/68/EU	On the harmonisation of the laws of the Member States relating to the making available on the market of pressure equipment		
Commission Regulation (EU) 2015/1095	Commission Regulation (EU) 2015/1095 of 5 May 2015 implementing Directive 2009/125/EC of the European Parliament and of the Council with regard to eco-design requirements for professional refrigerated storage cabinets, blast cabinets, condensing units and process chillers		
The relevant information can be transmitted in electronic form in response to a reasoned request by the national authorities.			
The partly completed machinery must not be put into service until the final machinery into which it is to be incorporated has been declared in conformity with the provisions of DIRECTIVE 2006/42/EC, where appropriate.			
The legal representative authorised to compile the relevant technical documentation is TEWIS SMART SYSTEMS, S.L.U, Auguste y Louis Lumière, 26 Parque tecnológico, Paterna, Valencia, Spain.			
Signed:			
Name:	Andrew Bowden		
Position:	Managing Director		
Location:	J & E Hall Limited, Questor House, 191 Hawley Road, Dartford, Kent, DA1 1PU		
Date:	29/09/2022		
<hr/>			
Form: JEH-C6-016e-01	Questor House, 191 Hawley Road, Dartford, Kent, DA1 1PU	Page 1 of 1	



RJ0110030009026

J & E Hall Limited
Hansard Gate
West Meadows
Derby, DE21 6JN
England

Tel: + 44 (0) 1332 253400
Fax: + 44 (0) 1332 371061
Email: helpline@jehall.co.uk
www.jehall.com

Issue: 01.12.2023

