
V3 FUSION DIGITAL TWIN SCROLL

Commercial Condensing Units

Variable Capacity

Medium Temperature Applications

ISSUE: 01.01.2025



IMPORTANT!

READ BEFORE PROCEEDING!

GENERAL SAFETY GUIDELINES




This guideline is intended for users to ensure safe installation, operation and maintenance of J&E Hall Digital Twin Scroll condensing units. This guideline is not intended to replace the system expertise available from the system manufacturers.

This equipment is a relatively complicated apparatus. During installation, operation, maintenance or service, individuals may be exposed to certain components or conditions including, but not limited to refrigerants, materials under pressure, rotating components, and both high and low voltage. Each of these items has the potential, if misused or handled improperly, to cause bodily injury or death. It is the obligation and responsibility of operating/service personnel to identify and recognize these inherent hazards, protect themselves, and proceed safely in completing their tasks. Failure to comply with any of these requirements could result in serious damage to the equipment and the property in which it is situated, as well as severe personal injury or death to themselves and people at the site.

This document is intended for use by owner-authorized operating/service personnel. It is expected that these individuals possess independent training that will enable them to perform their assigned tasks properly and safely. It is essential that, prior to performing any task on this equipment, this individual shall have read and understood this document and any referenced materials. This individual shall also be familiar with and comply with all applicable governmental standards and regulations pertaining to the task in question.

SAFETY SYMBOLS

The following symbols are used in this document to alert the reader to specific situations:

 WARNING	Warning! Risk of serious injury or death to person!
 CAUTION	Caution! Danger which can lead to serious damages!
 NOTICE	Notice! Risk of damage to equipment!

Disposal requirement



Your refrigeration product is marked with this symbol. This means that electrical and electronic products shall not be mixed with unsorted household waste. Do not try to dismantle the system yourself: the dismantling of the refrigeration system, treatment of the refrigerant, of oil and of other parts must be done by a qualified installer in accordance with relevant local and national legislation. Refrigeration equipment must be treated at a specialized treatment facility for re-use, recycling, and recovery. By ensuring this product is disposed of correctly, you will help to prevent potential negative consequences for the environment and human health. Please contact J & E Hall for more information.

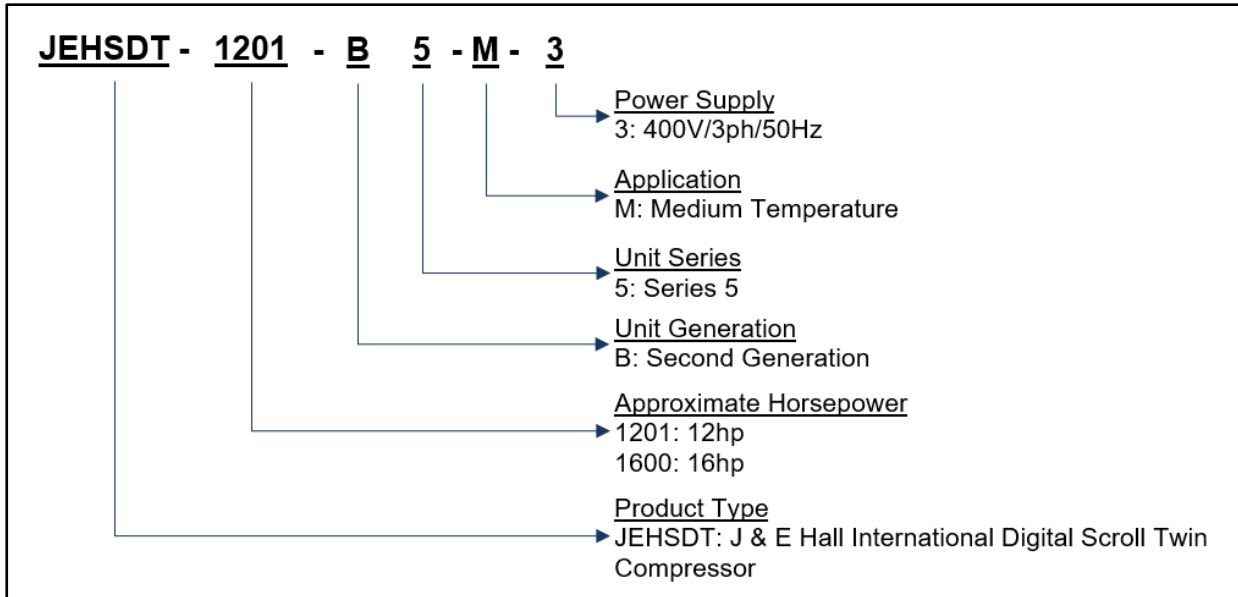
Batteries must be removed from the controller and disposed of separately in accordance with relevant local and national legislation.

Contents

NOMENCLATURE	1	<i>Figure 13: LCD Display</i>	14
<i>Figure 1: Product Nomenclature</i>	1	CONTROLLER HOME SCREEN.....	14
PRODUCT FEATURES	1	SWITCH UNIT ON / OFF (BY CONTROLLER)	15
SPECIFICATIONS	2	CHANGING SETPOINT AND REFRIGERANT SELECTION.....	15
<i>Table 1: Unit Data</i>	2	ALTERING LOW PRESSURE ALARM NOTIFICATION SETTING (OPTIONAL).....	16
<i>Table 2: Unit Dimensions and Weight</i>	2	<i>Table 15: Low Pressure Notification Alarm</i>	16
<i>Table 3: SEPR Data and Sound</i>	2	COMPRESSOR OPERATION FOR CAPACITY REGULATION	16
<i>Table 4: Performance Data R407A: 10K SH / OK SC</i> ...	3	<i>Figure 14: Regulation Request Versus Setpoint</i>	16
<i>Table 5: Performance Data R407F: 10K SH / OK SC</i> ...3		<i>Figure 15: Neutral Zone Timings Versus Setpoint</i> ...	17
<i>Table 6: Performance Data R448A/R449A: 10K SH / OK SC</i>	4	PRESSURE SWITCHES SETTINGS (MECHANICAL)	17
<i>Table 7: Performance Data R407A: 20°C RGT / OK SC</i>	4	<i>Table 16: Low- and High-Pressure Switch Settings</i> .	17
<i>Table 8: Performance Data R407F: 20°C RGT / OK SC</i> 4		PRESSURE RELIEF VALVE (PRV).....	17
<i>Table 9: Performance Data R448A/R449A: 20°C RGT / OK SC</i>	5	<i>Figure 16: Pressure Relief Valve 526E</i>	18
<i>Figure 2: Ecodesign Data JEHS DT-1201-B5-M-3 (SH10K)</i>	6	AC FAN SPEED MODULATION CONTROLLER.....	18
<i>Figure 3: Ecodesign Data JEHS DT-1600-B6-M-3 (SH10K)</i>	6	<i>Figure 17: Fan Control Curve</i>	18
<i>Figure 4: Ecodesign Data JEHS DT-1201-B5-M-3 (RGT 20°C)</i>	7	<i>Table 17: Fan Speed Controller Settings</i>	18
<i>Figure 5: Ecodesign Data JEHS DT-1600-B6-M-3 (RGT 20°C)</i>	7	FLOATING HEAD PRESSURE CONTROL	18
APPLICATION GUIDELINES	8	<i>Figure 18: Floating Head Pressure Control</i>	18
<i>Table 10: Application Envelope</i>	8	VOLTAGE MONITORING DEVICE MG73BF	19
SCROLL COMPRESSOR.....	8	<i>Table 18: LED Indication on MG73BF</i>	19
CRANKCASE HEATERS	8	OIL MANAGEMENT OM3	19
LOW PRESSURE SWITCH	8	<i>Figure 19: OM3 Sight Glass Control Zones</i>	19
<i>Figure 6: Low Pressure Switch Setting</i>	8	MANUAL BYPASS OPERATION	19
HEALTH AND SAFETY	9	EXTERNAL STATUS LIGHTS	19
GENERAL INFORMATION	9	<i>Table 19: Pilot Light Indicator</i>	19
INSTALLATION	10	ALARM SETTINGS.....	20
UNIT LOCATION	10	<i>Table 20: Alarm Default Settings</i>	20
<i>Figure 7: Positioning of Condensing Unit</i>	10	BACNET AND MODBUS PROTOCOL	20
<i>Figure 8: Air Circulation for Condenser</i>	10	<i>Table 21: Serial Cards for Different Protocol</i>	20
INSTALLATION CLEARANCES.....	10	SERVICE & MAINTENANCE	20
<i>Figure 9: Installation Clearance</i>	10	F-GAS REQUIREMENT	21
FIELD PIPING.....	10	<i>Table 22: Tonnes CO₂ Equivalent</i>	21
<i>Figure 10: Piping Layout for Outdoor Above Indoor</i> 11		<i>Table 23: Leak Inspection Frequency</i>	21
<i>Figure 11: Piping Layout for Outdoor Below Indoor</i> 11		APPENDIX	22
PRESSURE TESTING	11	<i>Table 24: Error Code</i>	22
<i>Table 11: Test Pressure</i>	11	<i>Table 25: Tightening Torque</i>	22
EVACUATION AND CHARGING.....	12	<i>Figure 20: Outline Drawing JEHS DT-1201-B5-M-3</i> ..	23
ELECTRICAL.....	12	<i>Figure 21: Outline Drawing JEHS DT-1600-B6-M-3</i> ..	23
<i>Table 12: Recommended Cable Size and Fuse</i>	12	<i>Figure 22: Wiring Diagram</i>	24
REVERSE ROTATION AND VOLTAGE UNBALANCE PROTECTION ...	13	<i>Figure 23: P&I Diagram</i>	25
COMMISSIONING	13	<i>Figure 24: Declaration of Conformity</i>	26
ACCESS TO CONTROLLER AND LCD DISPLAY	13	<i>Figure 25: Declaration of Incorporation</i>	27
<i>Figure 12: Access Point</i>	13	<i>Figure 26: EU Declaration of Conformity</i>	28
<i>Table 13: Factory Default Settings</i>	13	<i>Figure 27: EU Declaration of Incorporation</i>	29
PRE STARTUP CHECKS	13		
RUNNING THE UNIT	14		
USER TERMINAL INTERFACE – LCD DISPLAY.....	14		
<i>Table 14: LCD Display Button Functions</i>	14		

Nomenclature

Figure 1: Product Nomenclature



Product Features

J & E Hall Digital Twin Scroll is a packaged condensing unit adopt digital scroll technology for precise control on room temperature and humidity. The unit could be connected to multiple indoor units via copper connecting pipes to provide refrigeration cooling. The system is suitable for medium temperature applications such as cold rooms, display cabinets in convenience stores, general food storage, milk cooling, industrial processes etc.

Standard features for all medium temperature model:

- Copeland hermetic scroll compressors - ZBD & ZB (Digital & Fixed)
- Variable compressor capacity control
- 18 litre horizontal liquid receiver with PRV
- Fitted liquid line drier and sight glass
- External service valves
- Ball valves on compressors
- Check valve in discharge line
- Oil separator/reservoir with return line isolation valve
- OM 3 oil management system
- High- & Low-pressure transducers
- Manual low-pressure switch (adjustable)
- High pressure switches on compressors (auto reset cartridge type)
- Flexible pressure hoses
- IP rated enclosure
- Mains isolator
- Phase protection module
- Compressor manual motor starters with short circuit and overload protection
- Compressor contactors
- Advanced programmable controller
- LCD display
- Step Down Transformer 240V to 24V
- Fuse protection on controller, fan speed controller and backup system
- Mechanical by-pass circuit
- AC modulation fan speed control to both fans
- External indicator lights
- Alarm relay (volt free)
- Crankcase heaters on compressors
- Acoustic insulation to compressor compartment
- Operates with refrigerants R407A, R407F, R448A & R449A
- BACnet and Modbus Protocol feature (Additional Serial Card required)

Specifications

Table 1: Unit Data

Model	Compressor				Oil Separator	Electrical Data						Unit Connections		Coil Volume (L)	Liquid Receiver (L)	Air flow (m ³ /h)
	Model	Displacement	Charge Limit	Oil Charge		Compressor				Fan		Liquid	Suction			
		(m ³ /h)	(kg)	(L)	(L)	NC (A)	MOC (A)	MCC (A)	LRC (A)	No.	Total FLC (A)	(inch)	(inch)			
JEHSDT-1201-B5-M-3	ZB45KQE-TFD	17.1	4.8	1.89	1.5	9.2	13.1	14.2	74	2	1.8	3/4"	1-3/8"	8.8	18	7100
	ZBD45KQE-TFD	17.1	4.8	1.89		7.5	11.4	13.5	74							
JEHSDT-1600-B6-M-3	ZB57KCE-TFD	21.3	4.8	1.89	1.5	9.7	15.9	21.3	102	2	1.8	3/4"	1-3/8"	19	18	8200
	ZBD57KCE-TFD	21.3	4.8	1.89		9.7	15.9	21.3	102							

- Compressor Lubricant: Polyolester Oil – (Copeland Ultra 32 CC, Copeland Ultra 32-3MAF, Mobil EAL Artic 22 CC, Uniquema Emkarate RL32CF)
- NC: Nominal Current @ condition -10°C Te/ +32°C Ta
- MOC: Maximum Operating Current
- MCC: Maximum Continuous Current before compressor internal protector trip
- LRC: Locked Rotor Current
- FLC: Full Load Current

Table 2: Unit Dimensions and Weight

Model	Overall Dimensions (mm)			Mounting Dimensions (mm)		Dry Weight	Gross Weight
	Width	Depth	Height	Width	Depth	(kgs)	(kgs)
JEHSDT-1201-B5-M-3	1387	851	1697	940	808	315	386
JEHSDT-1600-B6-M-3	1735	854	1727	620/620 (Refer Outline Drawing)	808	380	470

Table 3: SEPR Data and Sound

Unit Model	SEPR (10K SH)				SEPR (20°C RGT)				SPL @ 10m dB(A)
	R407A	R407F	R448A	R449A	R407A	R407F	R448A	R449A	Loaded
JEHSDT-1201-B5-M-3	2.83	2.86	2.86	2.86	2.87	2.88	2.91	2.91	44
JEHSDT-1600-B6-M-3	2.66	2.70	2.72	2.72	N/A	N/A	2.78	2.78	44

- RGT: Return Gas Temperature
- SH: Superheat
- Sound Pressure Level (SPL) measured in an anechoic room at -10°C Te/+32°C Ta. Alternative conditions may produce different results.

The performance data shown in the **Tables 4 to 9** has the following criteria:

- Te: Evaporating Temperature (dew point)
- Ta: Ambient Temperature
- CC: Cooling Capacity (Watts)
- PC: Power Consumed (Watts)
- RGT: Return Gas Temperature
- SH: Suction Superheat
- SC: Subcooling OK
- COP: Coefficient of Performance

Table 4: Performance Data R407A: 10K SH / OK SC

MODEL	Ta / Te		-15	-10	-5	0	5
	Ta	Te					
JEHSDT-1201-B5-M-3	27	CC	15778	19216	22906	26779	30702
	27	PC	8406	8736	9194	9806	10609
	27	COP	1.88	2.20	2.49	2.73	2.89
	32	CC	14842	18080	21542	25140	
	32	PC	9123	9510	10019	10688	
	32	COP	1.63	1.90	2.15	2.35	
	35	CC	14086	17338	20838	24505	
	35	PC	9696	10016	10447	11032	
	35	COP	1.45	1.73	1.99	2.22	
	38	CC		16578	20121	23862	
	38	PC		10532	10883	11382	
	38	COP		1.57	1.85	2.10	
JEHSDT-1600-B6-M-3	27	CC	20600	25000	30100	35800	42200
	27	PC	11420	12180	12960	13700	14400
	27	COP	1.80	2.05	2.32	2.61	2.93
	32	CC	19480	23800	28300	33600	
	32	PC	12320	13020	14020	14880	
	32	COP	1.58	1.83	2.02	2.26	
	35	CC		22850	27250		
	35	PC		13740	14730		
	35	COP		1.67	1.86		
	38	CC		21900	26200		
	38	PC		14460	15440		
	38	COP		1.51	1.70		

Table 5: Performance Data R407F: 10K SH / OK SC

MODEL	Ta / Te		-15	-10	-5	0	5
	Ta	Te					
JEHSDT-1201-B5-M-3	27	CC	16217	20013	24125	28512	33079
	27	PC	8743	9052	9521	10174	11059
	27	COP	1.85	2.21	2.53	2.80	2.99
	32	CC	15227	18844	22757	26911	31213
	32	PC	9583	9941	10457	11173	12135
	32	COP	1.59	1.90	2.18	2.41	2.57
	35	CC	14451	18098	22066	26301	30718
	35	PC	10289	10547	10962	11577	12438
	35	COP	1.40	1.72	2.01	2.27	2.47
	38	CC		17352	21373	25690	
	38	PC		11186	11489	11994	
	38	COP		1.55	1.86	2.14	
JEHSDT-1600-B6-M-3	27	CC	20850	25450	30650	36450	43000
	27	PC	10970	11880	12750	13570	14300
	27	COP	1.90	2.14	2.40	2.69	3.01
	32	CC	19650	24250	28950	34300	40300
	32	PC	11660	12560	13660	14610	15490
	32	COP	1.69	1.93	2.12	2.35	2.60
	35	CC	18910	23225	27825	32950	
	35	PC	11700	13115	14235	14850	
	35	COP	1.62	1.78	1.96	2.22	
	38	CC		22200	26700		
	38	PC		13670	14810		
	38	COP		1.62	1.80		

Table 6: Performance Data R448A/R449A: 10K SH / OK SC

MODEL	Ta / Te		-15	-10	-5	0	5	10
	JEHSDT-1201-B5-M-3	27	CC	16973	20199	23740	27694	32170
27		PC	7720	8312	8945	9632	10381	11206
27		COP	2.20	2.43	2.65	2.88	3.10	3.33
32		CC	15858	19006	22454	26314	30685	35684
32		PC	8514	9107	9736	10411	11146	11950
32		COP	1.86	2.09	2.31	2.53	2.75	2.99
35		CC	14851	18010	21477	25367	29802	34901
35		PC	9287	9820	10378	10977	11626	12336
35		COP	1.60	1.83	2.07	2.31	2.56	2.83
38		CC	13858	17027	20507	24425	28920	34121
38		PC	10112	10574	11056	11570	12124	12731
38		COP	1.37	1.61	1.85	2.11	2.39	2.68
43		CC	12273	15442	18931	22891		
43		PC	11604	11926	12257	12607		
43		COP	1.06	1.29	1.54	1.82		
JEHSDT-1600-B6-M-3	27	CC	20500	24700	29500	35050	41500	48500
	27	PC	9780	10750	11830	12980	14180	15590
	27	COP	2.10	2.30	2.49	2.70	2.93	3.11
	32	CC	19570	23700	28050	33200	39250	46100
	32	PC	10310	11260	12490	13740	15070	16490
	32	COP	1.90	2.10	2.25	2.42	2.60	2.80
	35	CC	18990	22900	27150	32075	37800	
	35	PC	10675	11695	12930	14245	15630	
	35	COP	1.78	1.96	2.10	2.26	2.42	
	38	CC	18410	22100	26250	30950		
	38	PC	11040	12130	13370	14750		
	38	COP	1.668	1.82	1.96	2.10		
	43	CC	17390	20800				
	43	PC	11700	12850				
	43	COP	1.49	1.62				

Table 7: Performance Data R407A: 20° C RGT / OK SC

MODEL	Ta / Te		-15	-10	-5	0	5
	JEHSDT-1201-B5-M-3	27	CC		19776	23419	27203
27		PC		8736	9194	9806	10609
27		COP		2.26	2.55	2.77	2.92
32		CC		18718	22126	25622	
32		PC		9510	10019	10688	
32		COP		1.97	2.21	2.40	
35		CC			21457	25008	
35		PC			10447	11032	
35		COP			2.05	2.27	

Table 8: Performance Data R407F: 20° C RGT / OK SC

MODEL	Ta / Te		-15	-10	-5	0	5
	JEHSDT-1201-B5-M-3	27	CC		20349	24415	28734
27		PC		9052	9521	10174	11059
27		COP		2.25	2.56	2.82	3.00
32		CC		19260	23115	27182	31353
32		PC		9941	10457	11173	12135
32		COP		1.94	2.21	2.43	2.58
35		CC			22457	26591	30864
35		PC			10962	11577	12438
35		COP			2.05	2.30	2.48

Table 9: Performance Data R448A/R449A: 20° C RGT / OK SC

MODEL	Ta		-15	-10	-5	0	5	10
	Te							
JEHSDT-1201-B5-M-3	27	CC	17483	20720	24235	28110	32435	37292
	27	PC	7720	8312	8945	9632	10381	11206
	27	COP	2.26	2.49	2.71	2.92	3.12	3.33
	32	CC	16457	19607	23016	26778	30979	35717
	32	PC	8514	9107	9736	10411	11146	11950
	32	COP	1.93	2.15	2.36	2.57	2.78	2.99
	35	CC	15532	18678	22089	25864	30111	34936
	35	PC	9287	9820	10378	10977	11626	12336
	35	COP	1.67	1.90	2.13	2.36	2.59	2.83
	38	CC	14620	17762	21168	24954	29245	34158
	38	PC	10112	10574	11056	11570	12124	12731
	38	COP	1.45	1.68	1.91	2.16	2.41	2.68
	43	CC		16288	19674	23472		
	43	PC		11926	12257	12607		
	43	COP		1.37	1.61	1.86		
JEHSDT-1600-B6-M-3	27	CC	21250	25400	30200	35650	41900	48500
	27	PC	9780	10750	11830	12980	14180	15590
	27	COP	2.17	2.36	2.55	2.75	2.95	3.11
	32	CC	20400	24550	28800	33900	39650	46100
	32	PC	10310	11260	12490	13740	15070	16490
	32	COP	1.98	2.18	2.31	2.47	2.63	2.80
	35	CC	19860	23800	27975	32825	38300	
	35	PC	10675	11695	12930	14245	15630	
	35	COP	1.86	2.04	2.17	2.31	2.45	
	38	CC	19320	23050	27150	31750		
	38	PC	11040	12130	13370	14750		
	38	COP	1.75	1.90	2.03	2.15		
	43	CC		21900				
	43	PC		12850				
	43	COP		1.70				

Figure 2: Ecodesign Data JEHSDT-1201-B5-M-3 (SH10K)

Refrigerant fluid:						
Item	Symbol	R407A	R407F	R448A	R449A	Unit
Evaporating temperature*	t	-10				°C
Annual electricity consumption	Q	39268	40561	40925	40925	kWh/a
Seasonal Energy Performance Ratio	$SEPR$	2.83	2.86	2.86	2.86	
Parameters at full load and ambient temperature 32°C (Point A)						
Rated cooling capacity	P_A	18.08	18.84	19.01	19.01	kW
Rated power input	D_A	9.51	9.94	9.11	9.11	kW
Rated COP	COP_A	1.90	1.90	2.09	2.09	
Parameters at part load and ambient temperature 25°C (Point B)						
Declared cooling capacity	P_B	19.702	20.524	20.250	20.250	kW
Declared power input	D_B	8.405	8.687	8.279	8.279	kW
Declared COP	COP_B	2.34	2.36	2.45	2.45	
Parameters at part load and ambient temperature 15°C (Point C)						
Declared cooling capacity	P_C	21.551	22.513	21.980	21.980	kW
Declared power input	D_C	7.173	7.393	7.222	7.222	kW
Declared COP	COP_C	3.00	3.05	3.04	3.04	
Parameters at part load and ambient temperature 5°C (Point D)						
Declared cooling capacity	P_D	23.325	24.480	23.596	23.596	kW
Declared power input	D_D	6.054	6.309	6.320	6.320	kW
Declared COP	COP_D	3.85	3.88	3.73	3.73	
Parameters at full load and ambient temperature 43°C						
Cooling capacity	P_3	N/A	N/A	15.44	15.44	kW
Power input	D_3	N/A	N/A	11.93	11.93	kW
Declared COP	COP_3	N/A	N/A	1.29	1.29	
Other items						
Capacity control		Variable				
Coefficient of degradation for fixed and staged capacity units*	Cd	0.25				
Contact details	Daikin Refrigeration Malaysia Sdn. Bhd. Lot 10, Jalan Perusahaan 8, Kawasan Perusahaan Pekan Banting, 42700 Banting, Selangor Darul Ehsan.					

Figure 3: Ecodesign Data JEHSDT-1600-B6-M-3 (SH10K)

Refrigerant fluid:						
Item	Symbol	R407A	R407F	R448A	R449A	Unit
Evaporating temperature*	t	-10				°C
Annual electricity consumption	Q	54942	55280	53583	53583	kWh/a
Seasonal Energy Performance Ratio	$SEPR$	2.66	2.70	2.72	2.72	
Parameters at full load and ambient temperature 32°C (Point A)						
Rated cooling capacity	P_A	23.80	24.25	23.70	23.70	kW
Rated power input	D_A	13.02	12.56	11.26	11.26	kW
Rated COP	COP_A	1.83	1.93	2.10	2.10	
Parameters at part load and ambient temperature 25°C (Point B)						
Declared cooling capacity	P_B	26.100	26.550	25.550	25.550	kW
Declared power input	D_B	11.460	11.280	10.320	10.320	kW
Declared COP	COP_B	2.28	2.35	2.48	2.48	
Parameters at part load and ambient temperature 15°C (Point C)						
Declared cooling capacity	P_C	29.400	29.600	28.350	28.350	kW
Declared power input	D_C	9.480	9.480	9.110	9.110	kW
Declared COP	COP_C	3.10	3.12	3.11	3.11	
Parameters at part load and ambient temperature 5°C (Point D)						
Declared cooling capacity	P_D	29.900	30.050	28.850	28.850	kW
Declared power input	D_D	9.200	9.210	8.950	8.950	kW
Declared COP	COP_D	3.25	3.26	3.22	3.22	
Parameters at full load and ambient temperature 43°C						
Cooling capacity	P_3	N/A	N/A	20.80	20.80	kW
Power input	D_3	N/A	N/A	12.85	12.85	kW
Declared COP	COP_3	N/A	N/A	1.62	1.62	
Other items						
Capacity control		Variable				
Coefficient of degradation for fixed and staged capacity units*	Cd	0.25				
Contact details	Daikin Refrigeration Malaysia Sdn. Bhd. Lot 10, Jalan Perusahaan 8, Kawasan Perusahaan Pekan Banting, 42700 Banting, Selangor Darul Ehsan.					

Figure 4: Ecodesign Data JEHSDT-1201-B5-M-3 (RGT 20°C)

Refrigerant fluid:		R407A	R407F	R448A	R449A	
Item	Symbol	Value				Unit
Evaporating temperature*	t	-10				°C
Annual electricity consumption	Q	40070	41072	41400	41400	kWh/a
Seasonal Energy Performance Ratio	$SEPR$	2.87	2.88	2.91	2.91	
Parameters at full load and ambient temperature 32 °C (Point A)						
Rated cooling capacity	P_A	18.72	19.26	19.61	19.61	kW
Rated power input	D_A	9.57	9.94	9.11	9.11	kW
Rated COP	COP_A	1.96	1.94	2.15	2.15	
Parameters at part load and ambient temperature 25 °C (Point B)						
Declared cooling capacity	P_B	20.230	20.825	20.768	20.768	kW
Declared power input	D_B	8.460	8.687	8.279	8.279	kW
Declared COP	COP_B	2.39	2.40	2.51	2.51	
Parameters at part load and ambient temperature 15 °C (Point C)						
Declared cooling capacity	P_C	21.948	22.681	22.381	22.381	kW
Declared power input	D_C	7.217	7.393	7.222	7.222	kW
Declared COP	COP_C	3.04	3.07	3.10	3.10	
Parameters at part load and ambient temperature 5 °C (Point D)						
Declared cooling capacity	P_D	23.597	24.521	23.883	23.883	kW
Declared power input	D_D	6.087	6.309	6.320	6.320	kW
Declared COP	COP_D	3.88	3.89	3.78	3.78	
Parameters at full load and ambient temperature 43 °C						
Cooling capacity	P_3	N/A	N/A	16.29	16.29	kW
Power input	D_3	N/A	N/A	11.93	11.93	kW
Declared COP	COP_3	N/A	N/A	1.37	1.37	
Other items						
Capacity control		Variable				
Coefficient of degradation for fixed and staged capacity units*	Cd	0.25				
Contact details	Daikin Refrigeration Malaysia Sdn. Bhd. Lot 10, Jalan Perusahaan 8, Kawasan Perusahaan Pekan Banting, 42700 Banting, Selangor Darul Ehsan.					

Figure 5: Ecodesign Data JEHSDT-1600-B6-M-3 (RGT 20°C)

Refrigerant fluid:		R448A	R449A	
Item	Symbol	Value		Unit
Evaporating temperature*	t	-10		°C
Annual electricity consumption	Q	54361	54361	kWh/a
Seasonal Energy Performance Ratio	$SEPR$	2.78	2.78	
Parameters at full load and ambient temperature 32 °C (Point A)				
Rated cooling capacity	P_A	24.55	24.55	kW
Rated power input	D_A	11.26	11.26	kW
Rated COP	COP_A	2.18	2.18	
Parameters at part load and ambient temperature 25 °C (Point B)				
Declared cooling capacity	P_B	26.250	26.250	kW
Declared power input	D_B	10.320	10.320	kW
Declared COP	COP_B	2.54	2.54	
Parameters at part load and ambient temperature 15 °C (Point C)				
Declared cooling capacity	P_C	28.850	28.850	kW
Declared power input	D_C	9.110	9.110	kW
Declared COP	COP_C	3.17	3.17	
Parameters at part load and ambient temperature 5 °C (Point D)				
Declared cooling capacity	P_D	29.250	29.250	kW
Declared power input	D_D	8.950	8.950	kW
Declared COP	COP_D	3.27	3.27	
Parameters at full load and ambient temperature 43 °C				
Cooling capacity	P_3	21.90	21.90	kW
Power input	D_3	12.85	12.85	kW
Declared COP	COP_3	1.70	1.70	
Other items				
Capacity control		Variable		
Coefficient of degradation for fixed and staged capacity units*	Cd	0.25		
Contact details	Daikin Refrigeration Malaysia Sdn. Bhd. Lot 10, Jalan Perusahaan 8, Kawasan Perusahaan Pekan Banting, 42700 Banting, Selangor Darul Ehsan.			

Application Guidelines



NOTICE

It should ensure that the refrigeration system which adopts this condensing unit **MUST** have a liquid line solenoid valve controlled by a thermostat for each evaporator. Failure to fulfill this requirement causes liquid compression and consequently reduces lifetime of compressor.



CAUTION

Ensure that new compressors are not subjected to liquid abuse. Turn the crankcase heater **ON** for 12 hours before starting the compressor to avoid oil dilution and bearing malfunction.

Table 10: Application Envelope

Operating Limits	Recommendation
Discharge gas temperature	Maximum 120°C (defaulted in software)
Condenser coil temperature	Maximum 60°C (defaulted in software)
Low pressure side	Minimum 0.5barg; Maximum 19barg
High pressure side	Maximum 28barg
Evaporator outlet superheat	Above 6K (to avoid liquid flood back)
Suction gas superheat at compressor inlet	Not more than 20K
Voltage supply	Min: 360V, Max: 440V
Phase asymmetry	+/- 2%
Frequency	50Hz +/- 1%
Outdoor ambient	Min: -15°C, Max: 43°C (with standard wiring: fan speed controller in the circuit)
Maximum pipe run	50m

Suction line shall be insulated to avoid:

- High superheat during high ambient condition can create high discharge temperature.
- Too low superheat during low ambient condition that can condense refrigerant inside suction line.

Scroll Compressor

Both three phase digital scroll and fixed scroll compressor motors are designed to run only in one direction. The correct rotation of a three-phase compressor motor depends on the connection of the three incoming phases to the unit. Correct rotation can be determined by a drop in suction pressure and a rise in discharge pressure when the compressor is energized. Running the compressor for a short period of time in reverse direction will have no negative impact but prolonged running in reverse direction may cause premature failure.

To reverse the rotation of a three-phase fixed and digital scroll compressor, shut off the incoming power supply to the unit, swap connection of any two of the three incoming phases at the unit isolator, reapply power to the unit and following compressor restart, recheck operating pressures.

A clicking sound is audible during compressor start-up and shut down, it is entirely normal and has no effect on compressor durability.

Crankcase Heaters

Crankcase heater is required to remain energized during the compressor off cycles. The initial start in the field is a very critical period for any new compressor because all load-bearing surfaces are new and require a short break-in period to carry high loads under adverse conditions. Thus, the crankcase heater must be turned on a minimum of 12 hours before the first time start, to prevent oil dilution and bearing stress on initial start-up.

To energize crankcase heater while keeping compressor OFF, turn the isolator switch to ON position and motor circuit breaker to OFF position.

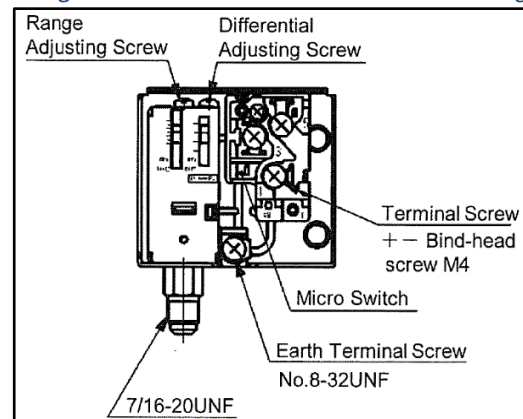


CAUTION

Ensure that new compressors are not subjected to liquid abuse. Turn the crankcase heater on 12 hours before starting the compressor to avoid oil dilution and bearing malfunction.

Low Pressure Switch

Figure 6: Low Pressure Switch Setting



The pressure switch fitted to condensing units with auto reset for low pressure is factory preset to 1.0 bar cut-out. **Do not set low pressure cut-out lower than factory default setting.**

Setting procedure for Low Pressure switch

- **Range:** Turning the range adjusting screw (2) clockwise will decrease the cut-in pressure setting. Turning the range adjusting screw anti-clockwise will increase the cut-in pressure setting.
- **Differential:** Turning the differential adjusting screw (3) clockwise will increase the differential pressure setting. Turning the differential adjusting screw anti-clockwise will decrease the differential pressure setting.
- Lock the spindle with locking plate after setting.

Health and Safety



Only qualified personnel, who are familiar with refrigeration systems and components including all controls, should perform the installation and start-up of the system. To avoid potential injury, use care when working around coil surfaces or sharp edges of metal cabinets. All piping and electrical wiring should be installed in accordance with all applicable standards and local by-laws.

General Information

Before Installation

- Ensure the units received are the correct models for the intended application.
- Ensure the refrigerant, voltage and MWP are all suitable for the proposed application.
- Check there is no damage to the units. Any damage should be reported to the supplier immediately.
- Check that the proposed equipment locations are suitable and provide adequate support for the weight of the units.

Offloading and Lifting

- Whenever a condensing unit is lifted, it should be from the base and, where possible, all packing and protection is kept in position.
- If lifting equipment is required, ensure that it is suitable, certificated, and that the operators are qualified to use it.
- When using a fork-lift or pallet truck to lift the unit, the two support points should be sufficiently apart to give stability when lifting and suitably placed to distribute the load on the forks.
- If slings are used, care should be taken to ensure that the slings do not crush the casework or coil.
- When lifting by crane, use spreader bars to prevent compressing the top of the equipment.
- Do not drop the unit. Should this inadvertently happen, it should be immediately unpacked and inspected for damage.
- Use the appropriate spreader bars/lifting sling with the holes and lugs provided.

During Installation and subsequent maintenance

- Installation and maintenance are to be performed only by qualified personnel who are familiar with local codes and regulations and experienced with this type of equipment.
- Safe working methods are identified, and operatives have suitable Personal Protective Equipment (PPE).
- Ensure the working area has adequate ventilation during brazing procedures.
- The units contain moving machinery and electrical power hazards, which may cause severe injury or death. Disconnect and shut off power before installation or service of the equipment.
- Refrigerant release into the atmosphere is illegal. Proper evacuation, recovery, handling, and leak testing procedures must be observed all the time.
- Units must be **grounded to the screw terminal labelled**

- No maintenance work should be attempted prior to disconnecting the electrical supply.
- The electrical covers and fan guards must remain fitted all the time.
- Use of the units outside of the design conditions and the application for which the units were intended may be unsafe and be detrimental to the units, regardless of short- or long-term operation.
- The units are not designed to withstand loads or stress from other equipment or personnel. Such extraneous loads or stress may cause failure/leak/injury.
- The units are not designed to operate with any restrictions such as heavy snowfall around them. Additional measures (such as shielding of the units) shall be implemented as required.
- The installer must fix the unit securely on installation using the M8 bolt holes in the unit feet to prevent instability from accidental contact or from exposure to the elements (e.g., wind).
- In some circumstances, a suction accumulator (not supplied) may be required. It offers protection against refrigerant flood back during operation and against off-cycle migration by adding internal free volume to the low side of the system.
- Tests must be conducted to ensure the amount of off-cycle migration to the compressor does not exceed the compressor's charge limit.
- After installation, the system should be allowed to run for 3 – 4 hours. The oil level should then be checked and topped up as necessary. It should then be rechecked after 24 hours once the system has stabilized. The oil level should be visible at least $\frac{1}{2}$ - $\frac{3}{4}$ way up the compressor oil sight glass. Refer Page 2 for compressor lubricant code.

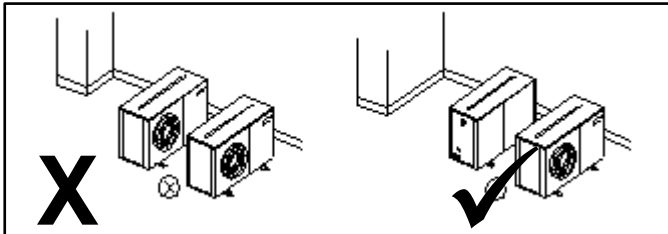


Installation

Unit location

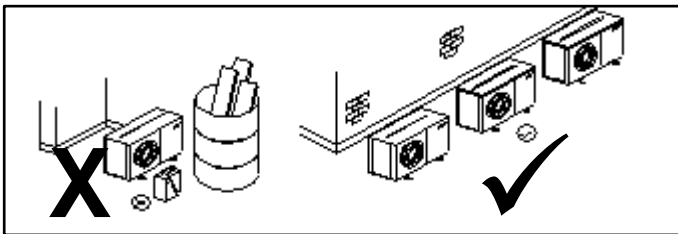
- To achieve maximum cooling capacity, the installation location for the condensing unit should be carefully selected.
- Install the condensing unit in such a way so that hot air ejected by the condensing unit cannot be drawn in again (short circuit of hot discharge air). Allow sufficient space for maintenance around the unit.

Figure 7: Positioning of Condensing Unit



- Ensure that there is no obstruction to air flow into or out of the unit. Remove obstacles which block air intake or discharge.

Figure 8: Air Circulation for Condenser

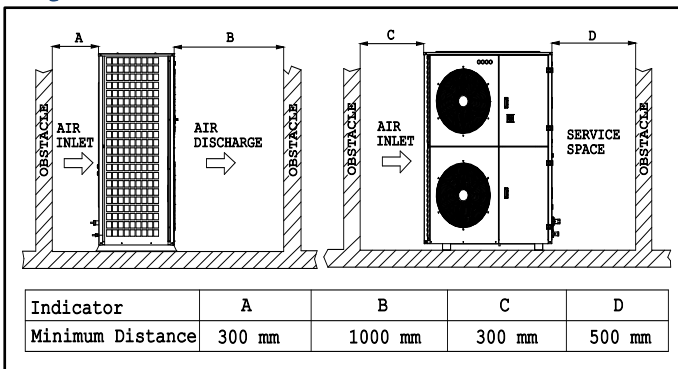


- The location must be well ventilated, so the unit can draw in and distribute plenty of air thus lowering the condensing temperature.
- To optimize the unit running conditions, the condenser coil must be cleaned at regular intervals.
- The unit must be level in all directions.
- It is recommended to install the unit on rubber grommet or vibration dampers.

Installation clearances

- The installation location should allow sufficient space for air flow and maintenance around the unit.

Figure 9: Installation Clearance



Field Piping



NOTICE

Pipe sizing should only be determined by qualified personnel. Correct line sizing will minimize the pressure drop and maintain sufficient gas velocity for proper oil return. All applicable standards must be observed in the installation of refrigerant piping.

To ensure satisfactory operation and performance, the following points should be noted:

- Pipework routes must be as simple and as short as possible.
- Avoid low points on pipework where oil can accumulate.
- Use only clean, dehydrated refrigeration grade copper tube with long radius bends.
- Avoid flare type connections and take great care when brazing. Use brazing filler alloys containing phosphorus such as BCuP-7 without flux for joining copper tubes.
- Dissimilar metals such as copper and brass shall be joined using an appropriate flux with high silver content filler material such as BAg-34. Apply flux sparingly to the clean tube only and in a manner to avoid leaving any excess inside of completed joints.
- Run braze without over filling to ensure there is no leakage into the tube.
- To prevent oxidation, blow oxygen free nitrogen through pipework when brazing.
- To prevent condensation on pipe surface, install insulation on all suction lines and on all pipes penetrating walls or passing through hot areas.
- Adequately support all pipe work at a maximum of 2-meter intervals.
- Suction gas velocity must be more than 4m/s for horizontal pipe and 8~12m/s for vertical pipe, to ensure good oil return.
- For the condensing unit located above the indoor unit, the use of U-trap and double suction risers is often required. These suction risers must always be fitted with a U-trap at the bottom and a P-trap at the top and never be higher than 4m unless a second U-trap system is fitted (Figure 10).
- Liquid lines should be sized to ensure a full supply of liquid refrigerant to the expansion device. Careful attention should be paid to sizing of liquid lines on large risers (maximum 6m).
- For the condensing unit located below the indoor unit (evaporator / display case), attention should be paid to the sizing of liquid lines on vertical riser by limiting the maximum rise to 6m (Figure 11).
- Suction pipework should slope gently back towards the unit to assist oil return to the compressor. A fall of approximately 2cm per meter of pipework is acceptable.
- Additional oil may be required if piping length exceeds 20m or multiple oil traps are fitted. Check the oil level closely during commissioning and add oil, as necessary. Add oil in small amounts. **Do not overfill the compressor!**
- All evaporators must have their own thermostat/liquid line solenoid valve.

- When installing a single condensing unit with multiple evaporators connected which operate independently, care should be taken to **ensure that the evaporating pressure/temperature does not fall outside the compressor operating limit at minimum load**. If there is potential for this scenario, consider multiple evaporators fed by a single solenoid valve or separate condensing units.
- The maximum recommended pipe length is 50m.
- It is recommended to install Pressure Relief Valve on the liquid receiver if there is a risk of fire incidence. Increasing temperature will lead to pressure increase in receiver.
- No valves and detachable joints shall be in areas accessible to the public except when they comply with EN 16084.

Figure 10: Piping Layout for Outdoor Above Indoor

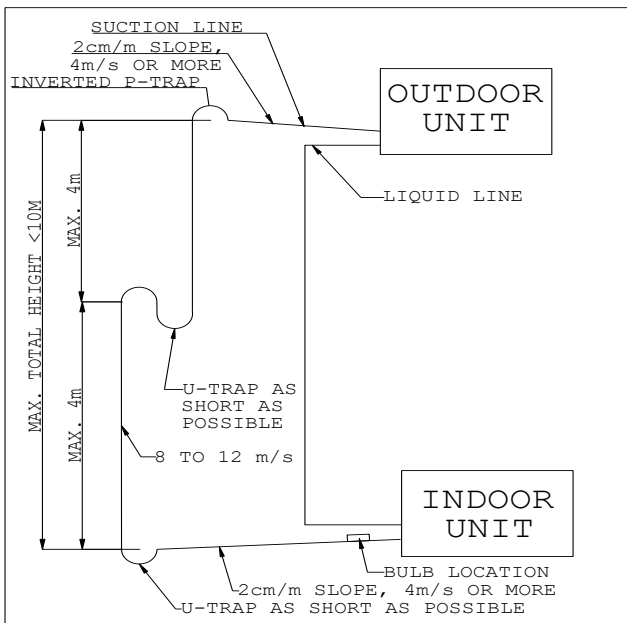
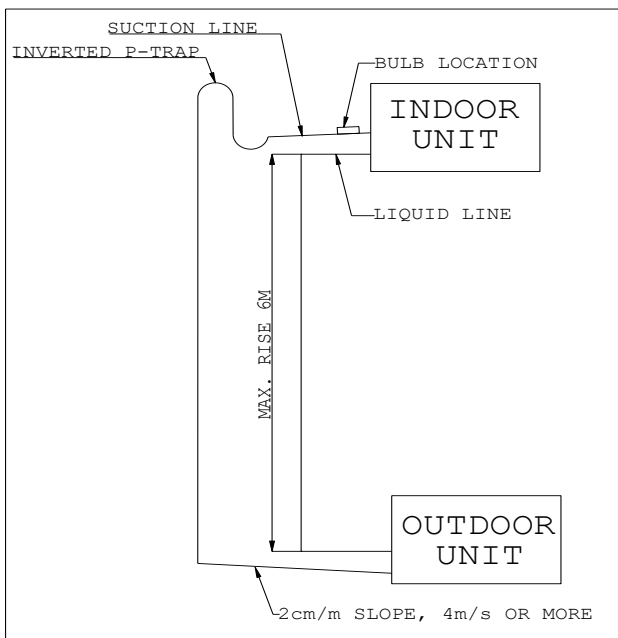


Figure 11: Piping Layout for Outdoor Below Indoor



One of the main factors affecting equipment reliability and compressor service life is refrigeration circuit contamination.

NOTICE

During installation, circuit contamination can be caused by:

- Brazing & Welding Oxides
- Filings & Particles from de-burring pipework
- Brazing Flux
- Moisture & Air

Pressure Testing



Never use oxygen, dry air, or acetylene for pressure testing systems as these may form an inflammable mixture.

CAUTION

- The condensing units are pressure tested in the factory prior to dispatch. All units come with a holding charge of oxygen free nitrogen. Remove the holding charge and indication tag prior to pipework installation using the service valve or regulator with pressure gauges and hoses.
- Once the pipework installation is complete, it should be pressure tested for leak prior to evacuation.
- A pressure leak test should be carried out using oxygen free nitrogen (OFN). A calibrated nitrogen pressure regulator must always be used. Before starting any pressure testing, ensure that the area surrounding the system is safe, inform relevant personnel and fit warning signs indicating high pressure testing. Also, use the correct Personal Protection Equipment (PPE).
- Always pressurize the system slowly, preferably in stages up to the maximum required pressure. Never exceed maximum test pressures shown in **Table 11**. Failure to obey the limit will cause premature failure on the pressure safety device. Example Pressure Relief Valve on receiver will discharge and need replacement if tested with pressure above 28barg.
- Listen for any possible leaks and check all joints with bubble spray. If any leaks are discovered, release pressure slowly from both suction and liquid line of system until empty, repair leak and then repeat pressure testing procedure. Never attempt to repair a leak on a pressurized system.
- A strength test should also be incorporated (to the installed pipework only) according to applicable standards.
- Once testing has been completed satisfactorily, release the pressure from the system gradually and safely to external atmosphere.

Table 11: Test Pressure

High Side, barg (psig)	Low Side, barg (psig)
28 (405)	19 (275)

Evacuation and Charging



NOTICE

Moisture prevents proper functioning of the compressor and the refrigeration system. Ensure that a good quality vacuum pump is used to pull a minimum vacuum of 250 microns (0.25 torr) measured at refrigeration system, and not at the vacuum pump gauge.

Once pressure testing has been completed, the system can now be evacuated to remove any moisture from the piping. This can be done as follows:

- Ensure any nitrogen charge is safely released from the system.
- Connect a gauge manifold to the connections on the service valves on the condensing unit.
- Connect a vacuum pump and vacuum gauge to the system.
- Ensure all gauge manifold and service valves in open position.
- Evacuate the system until vacuum is below 250 microns (0.25 torr).

Note: A triple evacuation procedure is recommended for all new systems or where moisture is suspected.

- Once the system is isolated and the vacuum pump is switched off, any rise in pressure indicates that either there may be a leak in the system or moisture is still present. In this case, recheck the system for leaks, repair as necessary, and then repeat the evacuation procedure.
- Once evacuation is completed satisfactorily, the vacuum pump and vacuum gauge can be removed. At this point, the refrigerant charge can be added to the system as required. Refrigerant blend must be charged in liquid form to avoid change of chemical properties.
- Ensure an adequate liquid charge (4~5barg) has been introduced to the high side of the system via schrader port of liquid receiver before starting the compressor.
- The remaining charge is slowly throttled into suction side until the installation has reached a level of stable nominal condition during operation. **Charging liquid into the suction side of the system should ONLY be done with a metering device.** Ensure a minimum operating pressure 0.5barg is maintained when add refrigerant to the suction side, otherwise overheating of the scroll may occur. Use calibrated weighing scales to record the amount of refrigerant added to the system.
- Stop the filling once obtain sufficient suction superheat and liquid subcooling, remove the cylinder from circuit.
- Fill the charge amount on the provided refrigerant charge label.



NOTICE

Refrigerant charge by judging the liquid sight glass does not guarantee as 100% correct way.

Electrical



NOTICE

The mains electrical supply to the condensing unit must be via a suitable motor rated circuit breaker or fuse. A mains isolator is fitted to all condensing units therefore an additional isolator is not required unless site conditions or regulations dictate differently.

J & E Hall Fusion Digital Twin Scroll condensing units require a 400 Volt / 3 phase / 50Hz supply, which must include a Neutral and an Earth. These systems are not suitable for any other supply voltages (other than a deviation of +/- 10% of the above values) and are not suitable for 60Hz supplies.

Below table lists recommended wiring sizes for the condensing unit power supply cables. These wiring sizes are valid for cable lengths up to 30m.

Table 12: Recommended Cable Size and Fuse

Model	Cable size, mm ² (from network to unit main switch)	Maximum Fuse Rating (A)
JEHSDT-1201-B5-M-3	10	40
JEHSDT-1600-B6-M-3	10	50

Note: **Table 12** is just a guideline for wire size. Installer might specify cable size different from this guideline, depending on the wire material and length, system design, ambient temperature, etc.

- Mains supply cable type and sizing must be selected to suit the application and the electrical installation should conform to the current local standards.
- Cables to the condensing unit should, wherever possible, be routed through the cable glands supplied on the rear of the units. Ensure no touching of supply cable to hot surface such as compressor body and discharge pipe.
- Connect the mains supply to the units as per the wiring diagrams.
- Ensure that the power supply corresponds to the unit and that the power supply is stable.
- Connect power supply according to the present norm and legal requirement. Ensure that the unit is properly connected to the ground. And termination of live wire at isolator switch in such a way that the compressor motor rotates in correct direction.
- The unit is equipped with a motor circuit breaker with overload protection for compressor. Overload protection is preset from factory and value can be found on the wiring diagram adhered on the control box cover.
- Ensure mechanical bypass switch is turned to OFF position (0) during normal operation.
- During refrigerant charging for full load condition, compressor capacity modulation is to be bypassed. Change only the mechanical bypass switch to position (1) when the power is isolated from controller. Failure to do so will trigger alarms and require power supply reset to clear the alarms.

Reverse Rotation and Voltage Unbalance Protection

The condensing unit does include voltage monitoring device, which will shut down the compressor if the incoming supply voltage falls outside the preset value, phase missing or incorrect phase terminated. Do not alter the factory preset OV and UV on the device, to avoid the compressor lose its' protection and overheating of motor may result.



NOTICE

All 3 phase scroll compressors require proper phase sequence to secure right rotation and therefore compression. The phase sequence must be secured between the network and isolator switch.



CAUTION

Do not use a megohmmeter nor apply power to the compressor while the system under vacuum as this may cause internal damage to the compressor.



CAUTION

Never start the compressor under vacuum (do not operate the compressor with the low-pressure cut-out bypassing), as this will cause the rotating part to overheat very quickly causing premature failure.



NOTICE

There must be no more than 10 compressor's start per hour. A higher number reduces the service life of the compressor. There is no minimum off time for scroll compressor. Adequate minimum run time is required to ensure proper oil return.

Commissioning

Access to Controller and LCD Display



WARNING

Warning! Only Authorized personnel are allowed to access the controller and LCD display.

To gain access to the electrical box, turn the mains isolator switch on the front of the unit to the OFF position, loosen the screws on the left-hand side of the door and open the top hinged door. The electrical box is located behind the door. Remove the screws in the electrical box cover to access components.

Figure 12: Access Point

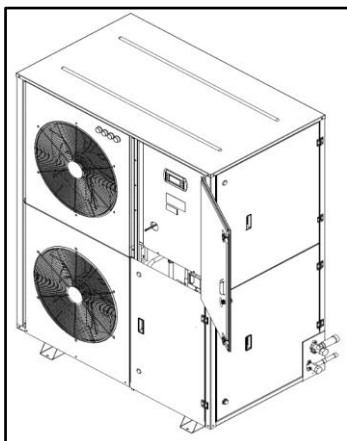


Table 13: Factory Default Settings

Description	Factory Default Setting	Remark
Voltage Monitoring Device MG73BF	Undervoltage: 90% Overvoltage: 105% Off delay: 0s	3phase compressors are protected from external wrong wiring.
Compressor setpoint	4.3barg, neutral zone differential: 0.5barg	Compressor is controlled at setpoint suction pressure. No loading/unloading if work within the range (setpoint \pm NZ differential). To change setpoint to suit application.
Condenser Fan Modulation	Setpoint: 16barg, differential: 3barg, Proportional. Cut In only when compressor is turned ON	Fan starts to rotate when compressor is turned ON and discharge pressure more than 13barg. Fan runs at full speed when pressure more than 19barg.
Refrigerant preset on controller	R448A	Type of refrigerant approved for selection: R407A, R407F, R448A, R449A
Low Pressure Switch	Cut In: 3barg, Differential: 2barg (Auto Reset)	To cut off compressor when suction pressure drops below 1.0barg * Software low pressure alarm threshold 1.2barg
High Pressure Switch	Cut Out: 28barg, Auto Reset: 22barg	Cartridge type high pressure switch auto reset once fault is removed, and high side pressure drop below 22barg.
Unit Status On/Off on keyboard	Off position	To switch unit ON/OFF, press PRG button to go Main Menu screen and select "A. On/Off Unit". Using the combination button of ENTER, UP/DOWN arrows to change the unit On/Off status.



NOTICE

All controller parameters are preset in the factory and are password protected. The only settings which can be changed are the compressor setpoint (suction pressure), the refrigerant type and the time/date. The fan setpoint is also preset but can be adjusted if required.



NOTICE

Please wait approximately 1 minute for controller initialization after switching on the main isolator.

Pre startup checks

Before starting the condensing unit, the following checks should be carried out as a minimum:

- Check electrical supply is correct and all connections are sound.

- All moving parts are free, and guards are fitted.
- Compressor oil level satisfactory.
- Mechanical bypass switch on the control panel is in the **OFF (0)** position.
- LCD display cable is connected to the controller to enable settings.
- Check setting of Low-Pressure Switch (back up control-maintain factory default setting).
- Overload set correctly on motor circuit breaker (maintain factory default setting as shown on wiring diagram).
- All valves are in correct operating position.
- Initial refrigerant charge.
- Crankcase heater had been energized for a minimum of 12 hours before compressor start-up.
- Gauge manifold connected to both low and high sides of system.
- Refer **Page 15** to change the required compressor setpoint and the type of refrigerant to suit the application. Else, maintain the factory default setting as shown in **Table 13**.

Running the unit

- Check green 'ON' LED on voltage monitoring device is lit. Refer **Table 18** if any fault indications are shown on the device. Switch off the power to the unit and check/modify incoming supply according to fault indicated.
- Switch unit ON at controller (Refer **Page 14**).
- Run the unit and check compressor and condenser fan operation.
- Check system pressures and temperatures, gas charge and running currents of motors to ensure correct operation.
- Check transducer / sensor readings are accurate (calibrated equipment required).
- Check compressor suction superheat. This should be between 10~20K in normal operating conditions.
- Final adjustment of controller settings.
- Check compressor oil levels (ensure there are no alarms on OM3) and adjust as necessary.
- Allow the system to run for 3 – 4 hours. Check compressor oil level and top up with the correct oil type (**Table 1**). Recheck the compressor oil level again after 24 hours operation.
- Carry out final leak test and ensure all panels/covers are fitted and screws tightened.
- Log all information along with the system model and serial numbers for future reference.
- Complete refrigerant labelling to comply with F-Gas regulations.
- Ensure that the customer / responsible persons are provided with basic operating instructions and where electrical isolators are situated in case of emergency.

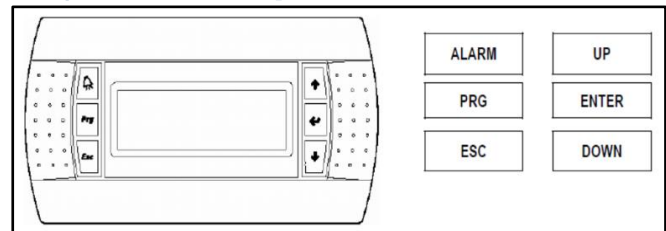
User Terminal Interface – LCD Display

The user terminal interface can be used to perform all the operations allowed by the program, display the operating conditions of the unit all the time, and set the parameters. It can be disconnected from the main board, and in fact is not required for operation.

Table 14: LCD Display Button Functions

ALARM	Displays the alarms. Press around 2 seconds to reset the alarm manually after the fault is removed.
UP	If the cursor is in the home position (top left corner), scrolls up the screens in the same group; if the cursor is in a setting field, and increases the value.
DOWN	If the cursor is in the home position (top left corner), scrolls down the screens in the same group; if the cursor is in a setting field, and decreases the value.
ENTER	Used to move the cursor from the home position (top left corner) to the setting fields, in the setting fields confirms the set value and moves to the next parameter.
PRG	Accesses the menu for selecting the group of parameters to be displayed/modified (access to the parameters is confirmed by pressing the [Enter] button).
ESC	Used to move back to previous screen/sub-menu. Continuous pressing of the ESC button will eventually return to the HOME screen.

Figure 13: LCD Display

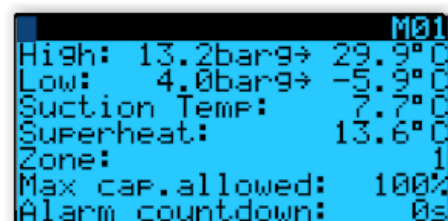


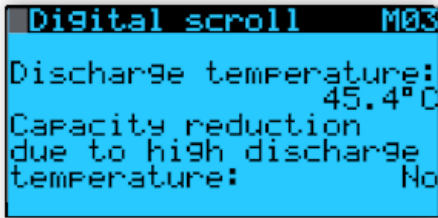
Controller Home Screen

1. Following controller power-up and initialisation process (approximately 1 minute), the controller home screen will appear as shown:



2. The low and high-sides conditions of the unit are displayed on screen M01. If **OFF by Key** is indicated in the lower box, it shows that the unit is switched OFF by the controller.
3. To switch the unit ON, follow instructions below. More information on the system conditions can be displayed by pressing the DOWN arrow.





4. The symbols against Compressor and Valve change depending on their status (whether compressor is running or not and whether the capacity valve is open or closed). The percentage value will also change depending on the amount of capacity being provided at the current time.
5. To return to the Home Screen – press ESCAPE button repeatedly until it is reached.
6. To enter the Programming menu press PRG button.

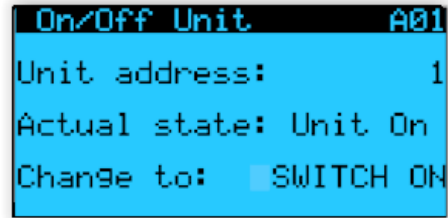
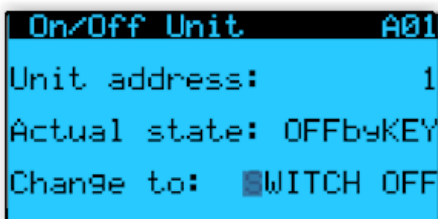
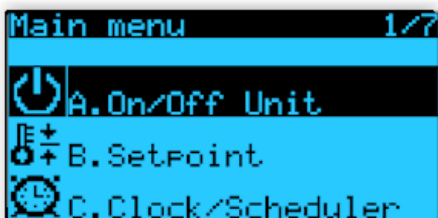
Switch Unit ON / OFF (By Controller)



Setting only possible to be modified when Controller under status of "OFFbyKEY".

NOTICE

1. With controller Home screen displayed, Press PRG button to go Main Menu screen and select "A. On/Off Unit".
2. Press ENTER button. Screen A01 is displayed.



3. Press ENTER button to move cursor from home position to SWITCH OFF value. Switch Unit ON by using UP/DOWN arrows. Press ENTER button to confirm.
4. Press ESC button repeatedly to return to Home Screen. This should now show ON by KEY at the bottom of the screen.
5. The unit will start up following a short delay (assuming all conditions for compressor start-up are met).

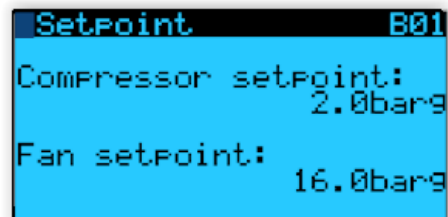
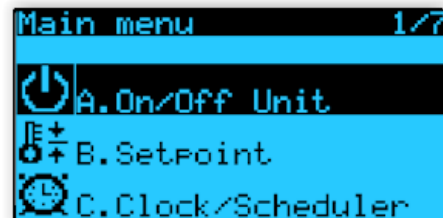
Changing Setpoint and Refrigerant Selection



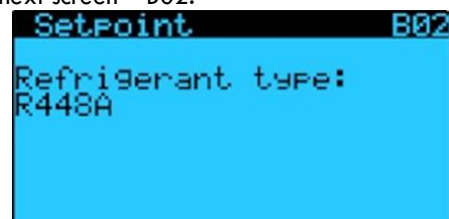
The only refrigerants which should be selected are R407A, R407F, R448A & R449A.

WARNING

1. With controller Home screen displayed **OFF by Key**, Press PRG button to go Main Menu screen and select "B. Setpoint" using DOWN button. Press ENTER button. Screen B01 is displayed.



2. Using ENTER button, move the cursor from the 'home' position to the Compressor Setpoint and adjust value as required by using UP or DOWN buttons.
3. Press the ENTER button again to move the cursor to the Fan Setpoint and adjust the value as required. Please note that the setpoint value of 16.0 bar is recommended for R407A/R407F/R448A/R449A operation.
4. Press ENTER button once more to return the cursor to the 'home' position.
5. From screen B01, use the DOWN button to move to the next screen – B02.

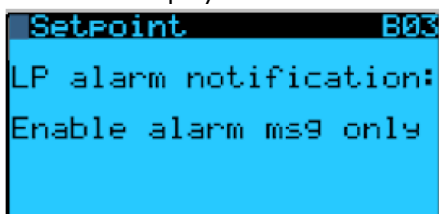


6. At screen B02, the Refrigerant Type can be selected. The default refrigerant is set as R448A.
7. To change the refrigerant, press ENTER to move the cursor from the 'home' position to the refrigerant type.

8. Use UP or DOWN buttons to scroll to different refrigerants.
9. With the required refrigerant selected, press ENTER button to confirm and return cursor to 'home' position.
10. Press ESC button repeatedly to return to Home screen.
11. The unit is now ready to run once the controller is set to ON.

Altering Low Pressure Alarm Notification Setting (Optional)




1. With controller Home screen displayed, Press PRG button to go Main Menu screen and select "B.Setpoint".
2. Press ENTER button and follow with down button till mask B03 is displayed.



3. Press ENTER button to move cursor from 'home' position to the selection. Select the desired low pressure alarm notification setting by UP/DOWN arrows. Three types of LP alarm notification setting are available:
 - i. Enable alarm msg only (by default)
 - ii. Disable all
 - iii. Enable all
4. With the required LP alarm notification setting selected, press ENTER button to confirm.
5. Press ESC button repeatedly to return to Home Screen.
6. The unit is now ready to run once the controller is set to ON.

The action for each low-pressure alarm notification setting when system pressure is lower than the threshold of the low-pressure transducer/switch is shown in **Table 15**.

Table 15: Low Pressure Notification Alarm

Notification Setting	Controller Display	Actions
Enable alarm msg only	<ul style="list-style-type: none"> Alarm code and warning symbol  are displayed. Event log is recorded 	K4R Alarm relay will NOT be activated
Disable all	<ul style="list-style-type: none"> Alarm code and warning symbol  are NOT displayed. Event log is recorded 	K4R Alarm relay will NOT be activated
Enable all	<ul style="list-style-type: none"> Alarm code and warning symbol  are displayed. Event log is recorded 	K4R Alarm relay will be activated after pre-set time delay (300s)

Compressor Operation for Capacity Regulation

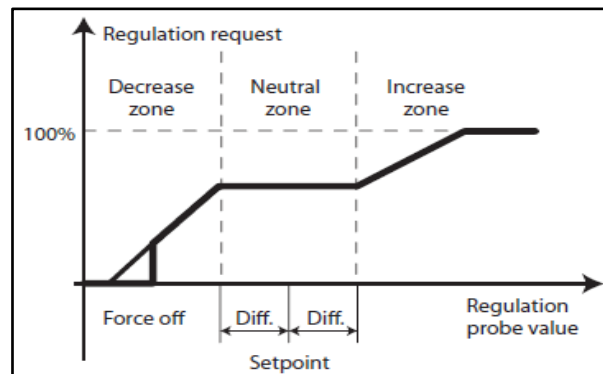
At initial start-up, the digital compressor will run at 50% capacity for 3 minutes followed by 100% capacity for 1 minute. Following this, the compressor (capacity) will be regulated in relation to the suction pressure as shown in **Figure 14**.



On twin scroll compressor units, the digital compressor is always the first to start and the last to stop.

NOTICE

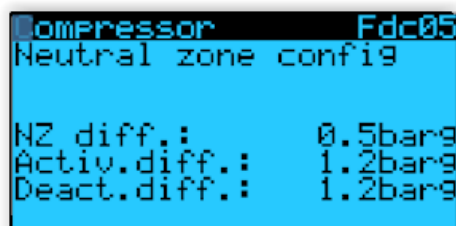
Figure 14: Regulation Request Versus Setpoint



When the suction pressure falls inside the neutral zone (setpoint +/- differential), the capacity is stable and there is no loading or unloading of the digital scroll compressor.

Once the suction pressure falls outside the neutral zone, the capacity request decreases or increases, depends on the deviation from the setpoint. (**Figure 14**).

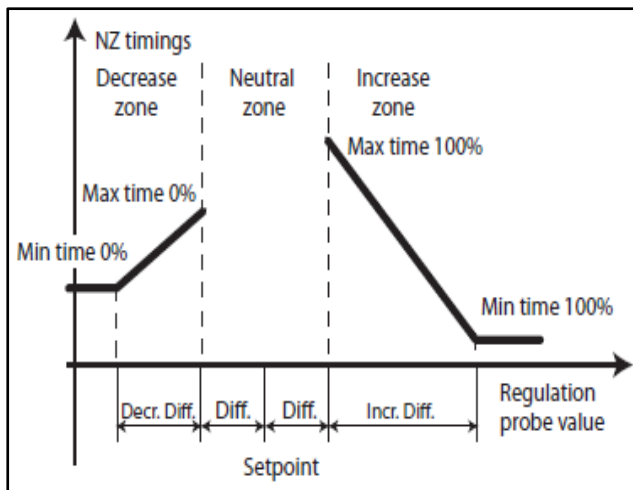
The default settings for pressure differentials in neutral, activation and deactivation zone as below (Fdc05).



The rate at which the capacity decreases or increases depends on the times defaulted in masks Fdc07, Fdc08 and Fdc09. This means that the further away the suction pressure moves away from the Neutral Zone (either above or below), the quicker the controller will adjust the compressor capacity (**Figure 15**).

The minimum times represent the time needed to change the capacity.

Figure 15: Neutral Zone Timings Versus Setpoint



```
Compressor Fdc07
Neutral zone

Load min.time: 120s
Load max.time: 600s
```

```
Compressor Fdc08
Neutral zone

Unload min.time: 120s
Unload max.time: 600s
```

```
Compressors Fdc09

Load up time: 10s
Load down time: 10s
```



NOTICE

None of the above settings can be altered.

The default cycle for pulse width modulation is 20seconds. When the required capacity is 10%, the compressor will be loading for 2s and unloading for 18s. This is managed by the compressor solenoid valve opening and closing time.

The rotalock connections as used on certain compressor models are sealed with Loctite 554 thread sealant. The connections should be leak assessed at commissioning and during service/maintenance visits. Refer **Table 25** for more information including recommended tightening torque.

Pressure Switches Settings (Mechanical)

The Saginomiya SNS low pressure switch fitted to the JEH Digital Twin Scroll condensing unit has **adjustable cut-out** and differential. High pressure protection is provided by a non-adjustable cartridge type high pressure switch.

High Pressure Safety Switch

The high-pressure safety switch is required to stop the compressor should the discharge pressure exceed the values shown in **Table 16**. The differential pressure is fixed at 6 bar (87 psi). Once tripped, it will create an alarm condition which requires manual reset at the controller.

Low Pressure Protection Switch

The adjustable low-pressure switch provides compressor protection from low suction pressure/evaporating temperature in Normal (controller) operation. In mechanical bypass mode, it provides compressor control and protects the compressor against deep vacuum operation, a potential cause of failure due to internal arcing and overheating. The low-pressure switch is factory set as **Table 16** for Normal (controller) operation.



NOTICE

If the Low-Pressure Switch was adjusted for operation in bypass mode, it must be reset back to factory setting as below before returning to Normal (controller) operation.

Table 16: Low- and High-Pressure Switch Settings

Refrigerant	Low Pressure, barg (Auto Reset)			High Pressure, barg (Auto Reset)	
	Min. Cut Out	Factory Default		Cut in	Cut Out
		Cut in	Differential		
R407A/R407F/ R448A/ R449A	1	3	2	22	28

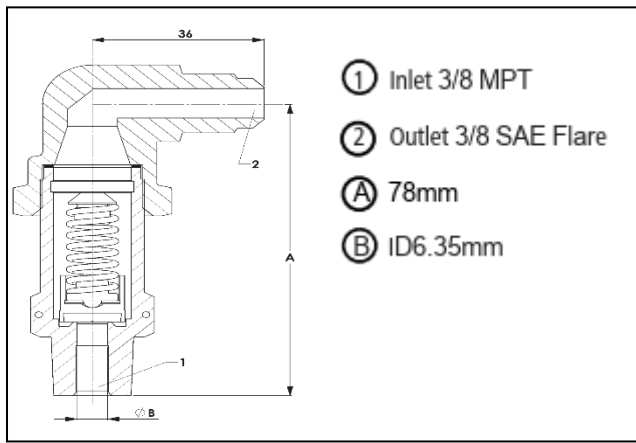
Pressure Relief Valve (PRV)

Pressure Relief Valve model 526E with **set pressure 31 barg** is installed on the liquid receiver to safely control overpressure example in the event of a fire.

Once the PRV has been discharged, replacement is recommended, as the set pressure can no longer be guaranteed. In line with Institute of Refrigeration Guidelines (UK), it was recommended that the PRV should be replaced at least every 5 years. These intervals may have to be reduced if other regulations apply.

Under normal system operating conditions, the pressure at the valve inlet is below 31 barg. Only under abnormal conditions should the PRV be open.

Figure 16: Pressure Relief Valve 526E



AC Fan Speed Modulation Controller

Both condenser fans are controlled by a phase cut modulating device based on discharge pressure and is configured to run only when compressor is run.

The fan under FSC control will start at 100% speed for approximately 5 seconds before starting to modulate as shown in Figure 17.

Fan control automatically switched to be controlled by external air temperature probe if fault discharge pressure transducer.

The default setting for fan speed control and the recommended settings to gain higher energy efficiency as published in the Eco-design data sheets are shown in Table 17.

Figure 17: Fan Control Curve

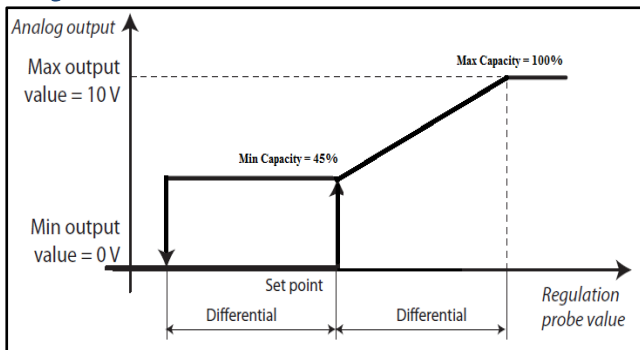
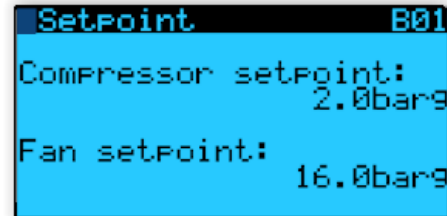


Table 17: Fan Speed Controller Settings

Refrigerant	R407A/R407F/R448A/ R449A	
Rated Condition	Performance Data (Default)	Eco-design Data
Condenser Fan (Fdc28)	Cut off enable: No	
Fan setpoint limit (Fdc16)	Minimum: 12.0barg Maximum: 28.0barg	Minimum: 8.0barg Maximum: 28.0barg
Setpoint (B01)	Fan setpoint: 16barg	Fan setpoint: 13.5barg
Regulation (Fdc11)	Differential: 3barg Dead band: 0.0barg	Differential: 5.5barg Dead band: 0.0barg

Fan setpoint could be changed via mask B01.



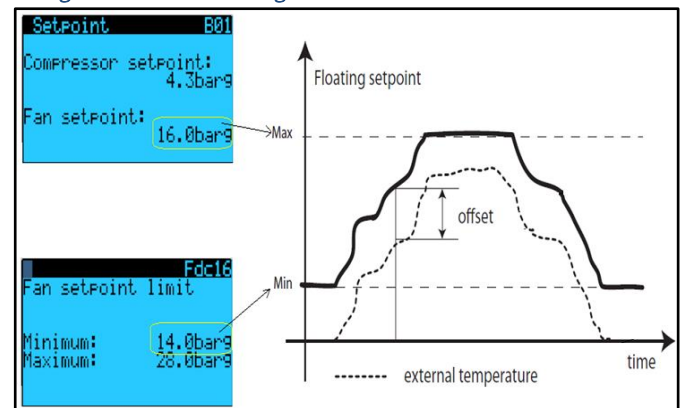
Floating Head Pressure Control

Fan speed could be selected to be controlled by external air temperature probe in mask Fdc26: Enable floating condensing setpoint. Change the default setting No to Yes.

Below is the algorithm to adjust setpoint based on external air temperature:

1. Sum the value of external air temperature and offset for air temperature.
2. Convert the temperature value into pressure (this depends on the refrigerant type) which will be the pressure setpoint.
3. Floating pressure setpoint is limited between the minimum and fan setpoint.

Figure 18: Floating Head Pressure Control



Example with R448A:

- Offset for air temperature = 2°C (Mask Fdc27)
- Minimum setpoint limit = 12.0barg (Mask Fdc16)
- Maximum setpoint limit = Fan setpoint = 16.0barg (Mask B01)
- External air temperature = 32°C (B1 in Mask D01)

1. External air temp. + offset = 32°C + 2°C = 34°C.
2. From R448A saturation table, 34°C, pressure = 13.3barg
3. Therefore, the floating condensing pressure setpoint = 13.3barg (which is in between 12.0 and 16.0barg)



NOTICE

This function should only be used when electronic expansion valves are used on the system evaporators.

Voltage Monitoring Device MG73BF

All units are equipped with voltage monitoring device to monitor the input power supply to protect the 3-phase compressor from overheating as result of working under phase lost, undervoltage or overvoltage.



NOTICE

A voltage monitoring device is to protect the compressor from reverse rotation due to the external wrong wiring to the condensing unit. The device cannot protect the compressor from reverse rotation due to wrong internal wiring or internal unit phase lost.

Table 18: LED Indication on MG73BF

LED (ON/OFF) Condition	LED			
	ON	UV	OV	BLINK: ASY, ON: REV
Power ON	ON	OFF	OFF	OFF
Phase reverse	ON	OFF	OFF	ON
Asymmetry	ON	OFF	OFF	BLINK
Under voltage	ON	ON	OFF	OFF
Over voltage	ON	OFF	ON	OFF
Phase Fail	BLINK	OFF	OFF	OFF
Phase Fail when input voltages lower than UV set point and below asymmetry	BLINK	ON	OFF	BLINK
Neutral Fail	ON	BLINK	BLI NK	BLINK

The off-delay timer will turn the system off after a set amount of time (default 0s) for following situation:

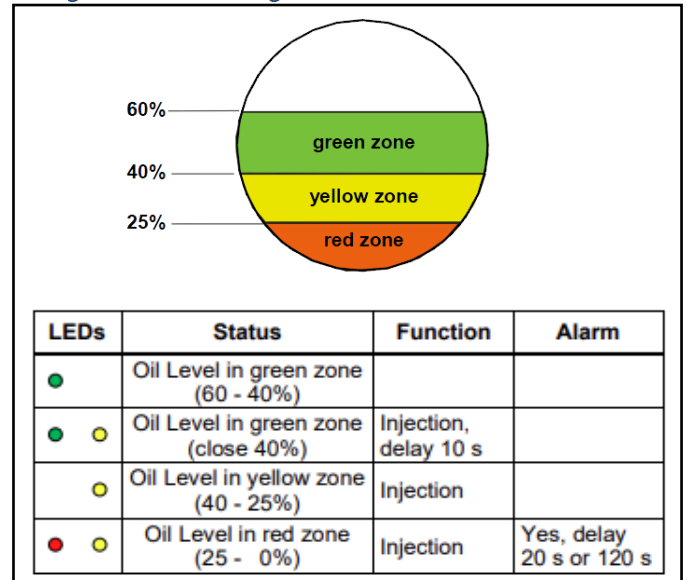
- Supply phases exceed over voltage or under voltage trip level setting.
- Any supply phase failure
- Line interruption
- Phase reverse occurrence
- Neutral failure



Oil Management OM3

OM3 is to protect the compressor against low oil level operation which can cause premature failure and additionally generate alarm signal. It uses a Hall-Sensor to measure the oil level. A magnetic float changes its position according to the oil level, not prone to errors by foaming or light. The hall sensor converts these magnetic field changes into an equivalent signal, which is used by the electronic controller to open or close an integrated solenoid valve which feeds missing oil directly into the compressor sump. If the oil level drops into the red zone, OM3 generates an alarm signal and the alarm contact (SPDT) changes into alarm state which use to shut down the compressor. In the Alarm status, OM3 is still feeding oil into compressor. If the oil level comes back to normal, the Alarm will be reset.

Figure 19: OM3 Sight Glass Control Zones



NOTICE

The compressor will be triggered off when there is red LED alarm from OM3.

Manual Bypass Operation

In the event of failure of the main electronic controller, the unit can be run temporarily in mechanical bypass mode to give 50% of unit capacity. By changing the position of the manual bypass switch mounted on the electrical box from '0' to '1', only the **fixed speed** compressor will run and will be controlled by the adjustable LP switch. In bypass mode, the condenser fan will run without fan speed control.



WARNING

Ensure the bypass switch is always at "0" position while running in electronic controller mode.

External Status Lights

There are four pieces of status lights which are visible from the front of the unit. The pilot lights indicate the unit current's status. When the pilot light is lit, it indicates:

Table 19: Pilot Light Indicator

Pilot Light	Description
Blue	Unit work under manual bypass mode
Green	Mains power onto unit
Yellow	Compressor run
Red	Alarm

Alarm Settings

The controller does protect the compressor from operating outside the unit's operating envelope. The defaulted high and low pressure/temperature alarms are shown in **Table 20**.

Example: When the low pressure falls below threshold value of 1.2barg, low pressure alarms will be triggered after countdown 10s. The compressor will auto restart after the suction pressure rise above the low-pressure switch cut in value: 3barg.

Table 20: Alarm Default Settings

Mask	Parameter	Settings
Fdc17	Low pressure alarm	
	Threshold (barg)	1.2
	Differential (barg)	0.8
Fdc18	Low pressure alarm	
	Startup delay (s)	10
	Running delay (s)	0
Fdc20	High pressure alarm	
	Threshold (barg)	28
	Differential (barg)	7
Fdc21	High condensing coil temp alarm	
	Threshold (°C)	60
	Delay time (s)	20
Fdc22	Fixed scroll high pressure temp alarm	
	Threshold (degC)	120
	Differential (degC)	20
	Delay time (s)	5

BACnet and Modbus Protocol

To enable BACnet or Modbus Protocol feature, an additional serial card and its' bracket (which need to be separately ordered) need to be fixed into the board.

Table 21: Serial Cards for Different Protocol

Protocol	Description
Modbus RTU	Optocoupled RS485 Serial Board (PCOS004850)
Modbus RTU Serial Card Bracket	Support for RS485 serial interface (PCOS00S030)
Bacnet MSTP	PCONET SE, RS485 card BACNET MS/TP PCO1000BD0)
Bacnet IP	PCOWEB SE, ethernet card IP (PCO1000WD0)
Bacnet IP/MSTP Serial Card Bracket	Bracket serial card PCO-WEB(PCOS00S010)

After plug in the serial card, it is required to configure the corresponding type of serial card in mask Fc01.

```

BMS config. Fc01
Supervisor system

Protocol:   MODEBUS
Speed:     19200
Ident:     1
    
```

Please contact J & E Hall for the BMS point list for Modbus and BACnet protocol.

Service & Maintenance



Warning! – Disconnect the mains electrical supply before servicing or opening the unit.

The condensing units are designed to give long life operation with minimum maintenance. However, they should be routinely checked, and the following service schedule is recommended under normal circumstances.

1. Compressor – Inspect at regular intervals.

- Check for refrigerant leaks on all joints and fittings.
- Check mountings for tightness and wear.
- Check operation of crankcase heater.
- Check electrical connections.
- Ensure that no abnormal noise or vibration is detected during the test run.
- Check the compressor oil levels and top up if required. The oil level should be ½ to ¾ way up the sight glass (where fitted).

2. Condenser Fan Motor & Blade – Clean and inspect at regular intervals.

- Check for abnormal noise, vibration, and fan imbalance.
- Ensure that the fan motor is clean and spins freely.
- Check that the condenser fan blade is clean and free from restriction and damage/imbalance.

Note: The fan motor is pre-lubricated, and factory sealed so no maintenance is necessary.

3. Condenser Coil – Clean and inspect at regular intervals.

- Check and remove the dirt and debris between the fins using a soft brush, low pressure compressed air/inert gas or a low-pressure sprayer utilizing clean water. A suitable chemical coil cleaner may be used as required. Accumulations of dirt on the condenser face can be removed with a soft bristle hand brush. When using liquids, ensure electrical items are isolated and correctly protected.
- Check and remove any obstacles which may hinder the airflow through the condenser coil.

Note: Do not use high pressure jet washer to clean the condenser coil.

4. Controls

- Check low pressure switch settings and controller settings (refer **Table 13**).
- Check overload setting on motor rated circuit breaker.

5. Power Supply – Inspect at regular intervals.

- Check the running current and voltage for the condensing unit.
- Check the electrical wiring and tighten the wires onto the terminal blocks if necessary.

6. Refrigerant Charge

- Check the refrigerant charge by ensuring that the system is operating correctly, the pressures are as expected and that the liquid line sight glass shows a full bore of liquid refrigerant.
- Carry out a full leak test.

7. Compressor replacement (rotalock connections)

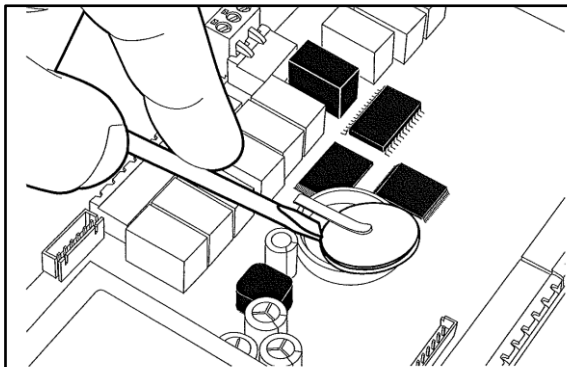
- The rotalock connections used on some compressor models are factory sealed with Loctite 554 thread sealant. If the rotalock connections need to be disassembled (e.g., compressor change), then they should be thoroughly cleaned and Loctite 554 reapplied before reassembly. In case of difficulty undoing the connections due to the sealant, apply heat to rotalock using a heat gun for several minutes and then loosen using hand tools whilst hot. Replacement of the 'O' ring seal may be required. Refer **Table 25** for recommended torque tightening values.

8. Part replacement/servicing (flare nut and fitting)

- Refer **Table 25** for recommended torque tightening values to tighten flare nut and flexible hose fitting during part replacement or servicing.

9. Unit decommissioning and disposal

- At the end of the unit's useful life, a suitably qualified engineer should decommission it. The refrigerant and compressor oil are classed as hazardous waste and as such must be reclaimed and disposed of in the correct manner, including completion of waste transfer paperwork. The unit components must be disposed of or recycled as appropriate in the correct manner.
- Do not dispose of the controller as municipal waste, it must be disposed of through specialist waste disposal centers. It contains a battery that must be removed and separated from the rest of the product according to the instructions provided, before disposing of the product. Improper use or incorrect disposal of the product may have a negative effect on human health and on the environment. The public or private waste collection systems defined by local legislation must be used for disposal.
- In the event of illegal disposal of electrical and electronic waste, the penalties are specified by the local waste disposal legislation.



The battery in the controller should be changed every three years.

9. Warranty

- The warranty as provided by J & E Hall on its products is subject to correct application, siting, and installation procedures together with subsequent recorded maintenance/servicing carried out in accordance with our recommendations. Failure to do so could result in the withdrawal of our warranty.

Please go to our website for our detailed warranty terms and conditions: www.jehall.co.uk

F-Gas Requirement

- The models of equipment covered in this Technical Manual rely on fluorinated greenhouse gases for their functioning.
- All unit models come from the factory pressurized with OFN (Oxygen Free Nitrogen) only.
- In F-Gas Regulation EU 517/2014, the requirement for leak testing on the system is based on the charge size in tonnes of CO₂ equivalent. Which means systems with higher GWP refrigerants will need to be leak tested more frequently than those with the same charge weight of a lower GWP refrigerant.
- The GWP (Global Warming Potential) values of refrigerants which are specified for use along with the three new thresholds for leak testing requirements based on TCO₂Eq (Tonnes CO₂ Equivalent) are as follows:

Table 22: Tonnes CO₂ Equivalent

Refrigerant	GWP	Refrigerant Charge - kg		
		5T CO ₂ Eq	50T CO ₂ Eq	500T CO ₂ Eq
R407A	2107	2.4	23.7	237
R407F	1825	2.7	27.4	274
R448A	1387	3.6	36.0	360
R449A	1397	3.6	35.8	358

Starting 1st January 2017, the requirement for leak detection and maintaining system logs changes from 3kg HFC to 5TCO₂Eq.

Table 23: Leak Inspection Frequency

System Charge (TCO ₂ eq)	Leak Inspection Frequency
e.g. 3.6 to 36 kg R448A	<ul style="list-style-type: none"> At least once every year.
5 to < 50	<ul style="list-style-type: none"> At least once every 2 years if a fixed leak detection system is fitted.

A refrigerant charge label is supplied with each unit (inside the electrical box). The total refrigerant charge for the system and the TCO₂Eq value must be entered on the label with indelible ink and must be adhered in the proximity of the product charging port. The label supplied will represent the refrigerants approved for use with that unit. An example of the unit label is as follows.

Contains fluorinated greenhouse gases			
Ref.	GWP	Charge (kg)	TCO ₂ Eq.
R407A	2107		
R407F	1825		
R448A	1387		
R449A	1397		

Use below formula to calculate the value of TCO₂Eq.

$$\text{TCO}_2 \text{ Eq value} = \frac{\text{Refrigerant Charge (kgs)} \times \text{Refrigerant GWP}}{1000}$$

Appendix

Table 24: Error Code

Code	Description	Reset type
A01	Clock board error	Auto
A08	Suction temperature probe fault	Auto
A09	Outdoor temperature probe fault	Auto
A10	Condensing coil temperature probe fault	Auto
A11	Discharge temperature probe 1 fault	Auto
A12	Discharge temperature probe 2 fault	Auto
A13	Discharge pressure transducer fault	Auto
A14	Suction pressure transducer fault	Auto
A15	Outside of operating envelope (Digital scroll)	Auto
A16	Condensing coil high temperature	Auto
A17	Compressor 1 high discharge temperature alarm	Auto
A18	Compressor 2 high discharge temperature alarm	Auto
A19	Compressor 1 overload trip (Digital)	Auto
A20	Compressor 2 overload trip (Fixed)	Auto
A22	Compressor 1 OM3 oil management	Auto
A23	Compressor 2 OM3 oil management	Auto
A24	Low pressure alarm by transducer	Auto
A25	High pressure alarm by transducer	Auto: less than 3 times in 30 minutes Manual: 3 times or more in 30 minutes
A26	Low pressure alarm by pressure switch	Auto
A27	Compressor 1 high pressure alarm by pressure switch	Manual
A28	Compressor 2 high pressure alarm by pressure switch	Manual

When the unit is triggered off by alarm, the alarm LED will be steady ON or blinking. To view the error, press button ALARM, ENTER and UP/DOWN to access alarm log history. Clear the fault accordingly before manual restart.

Table 25: Tightening Torque

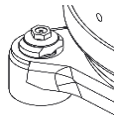
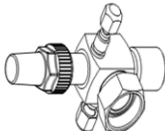
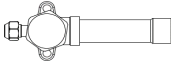
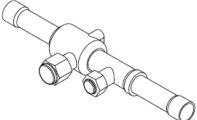
Model	Tightening Torque (Nm)										
	Compressor Mounting	Rotolock Valve				Service Valve (Cap)		Ball Valve (Cap)			Schrader Valve
		Compressor Suction and Discharge	OM3	Liquid Receiver	Oil Separator	Suction	Liquid	Suction	Discharge	Liquid	
JEHSDT-1201-B5-M-3	M8 (13Nm)	Brazed Connection	1-1/4"-12UNF (110-135 Nm)	1-1/4"-12UNF (110-135 Nm)	1-1/4"-12UNF (110-135 Nm)	M38*1.5mm (42-47Nm)	M30*1.5mm (42-47Nm)	~15	~10	~15	7/16" - 20UNF (14-16 Nm)
JEHSDT-1600-B6-M-3		1-1/4"-12UNF (110-135 Nm)							~15		
Graphic Presentation											N/A

Figure 20: Outline Drawing JEHSDT-1201-B5-M-3

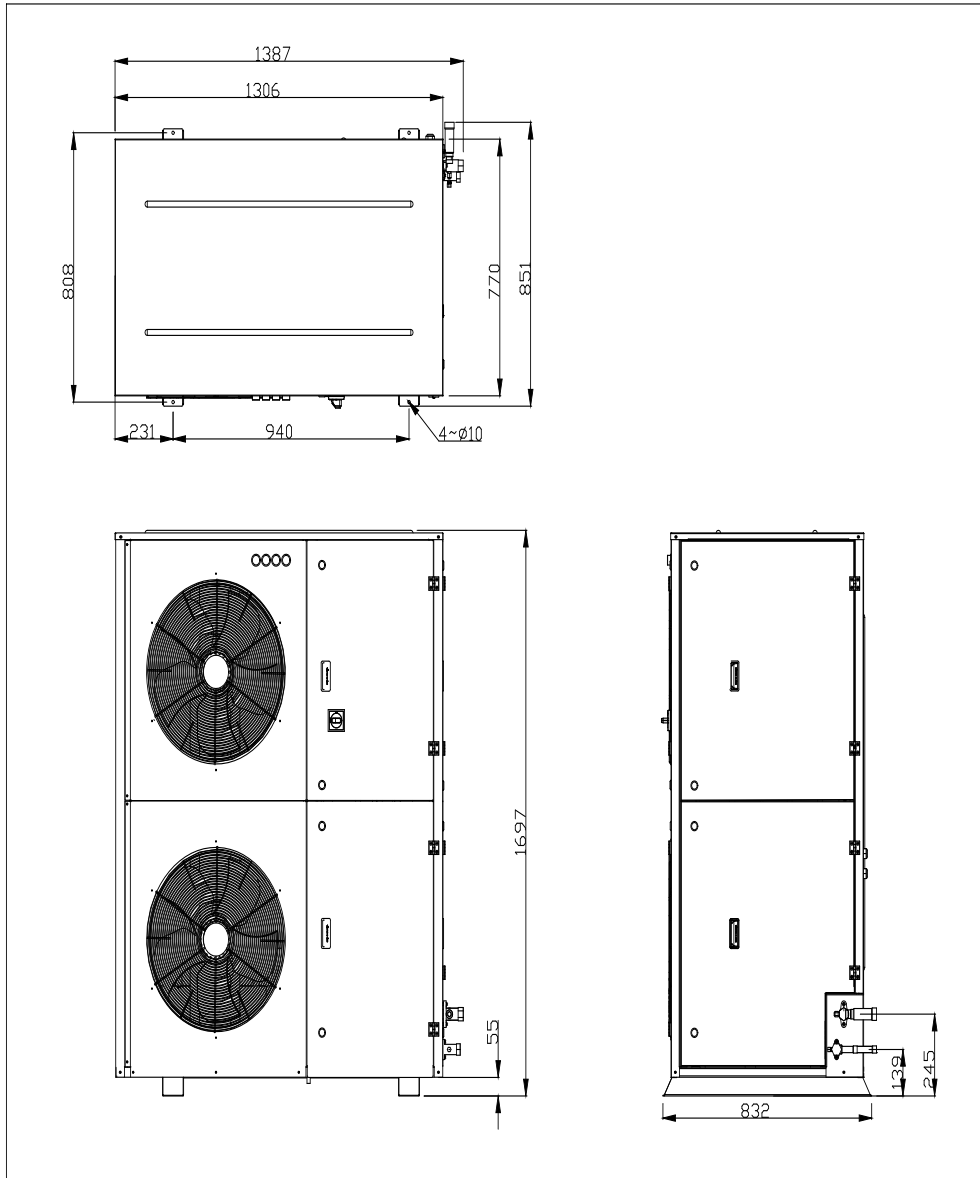


Figure 21: Outline Drawing JEHSDT-1600-B6-M-3

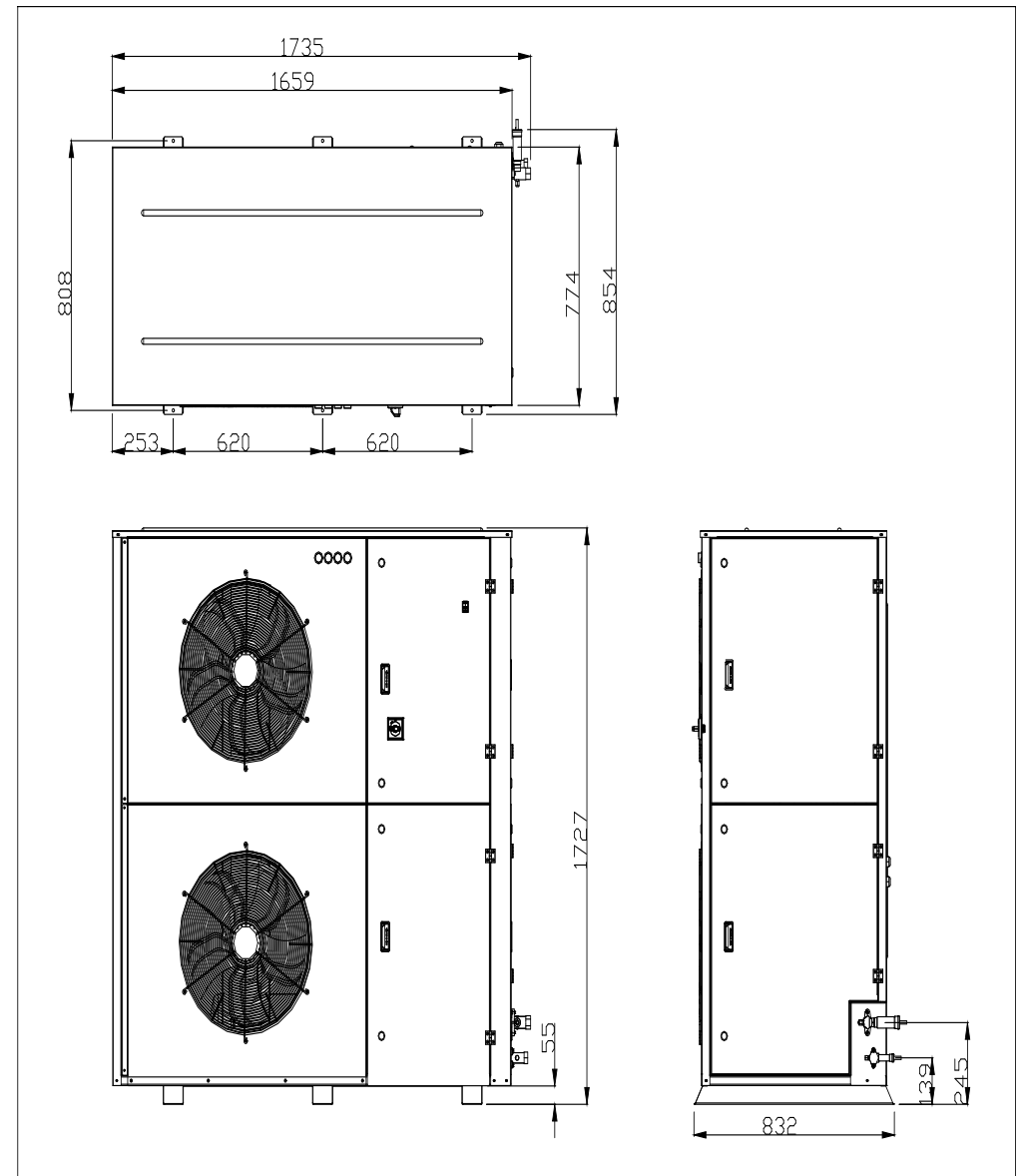


Figure 22: Wiring Diagram

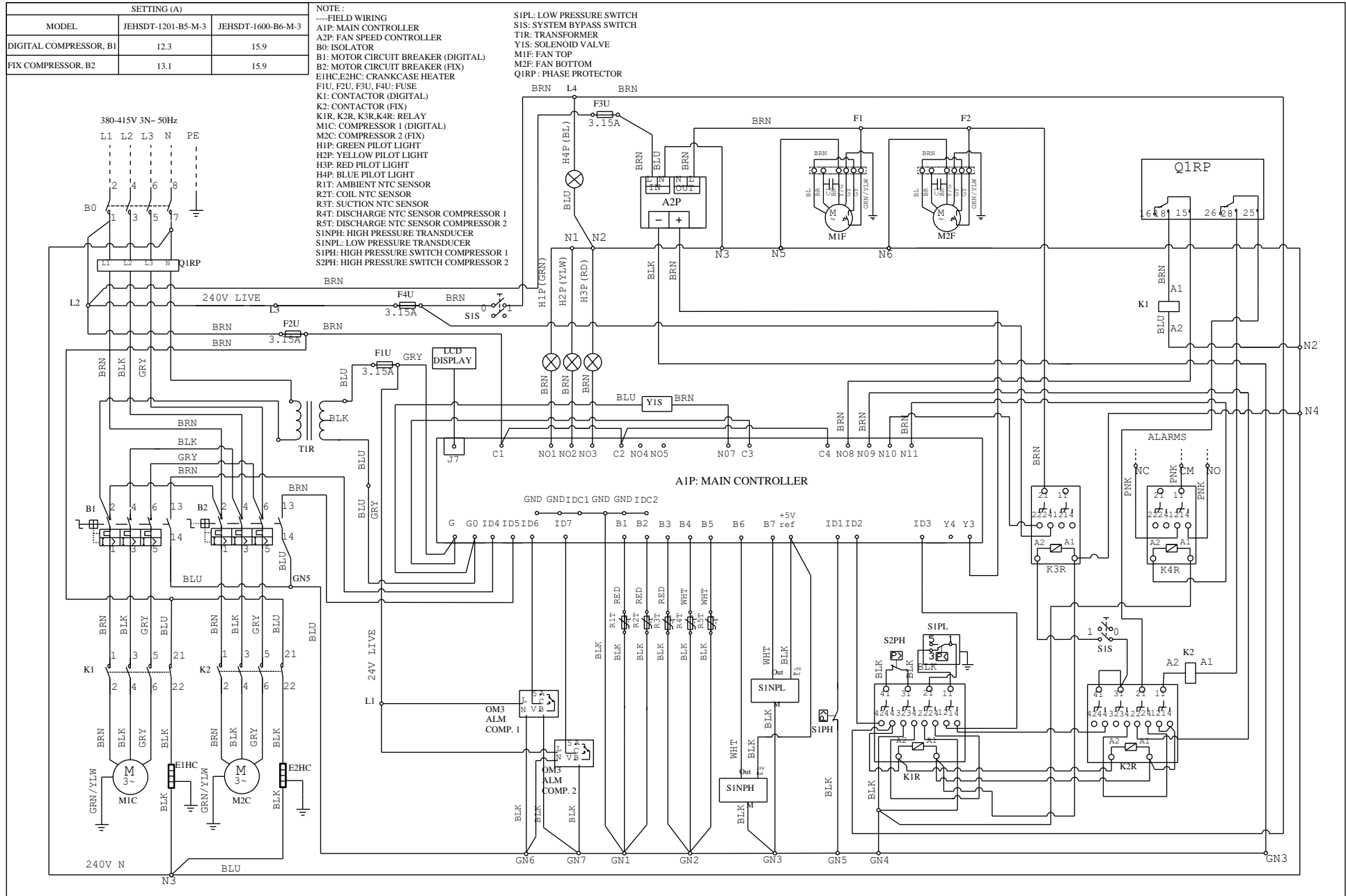


Figure 23: P&I Diagram

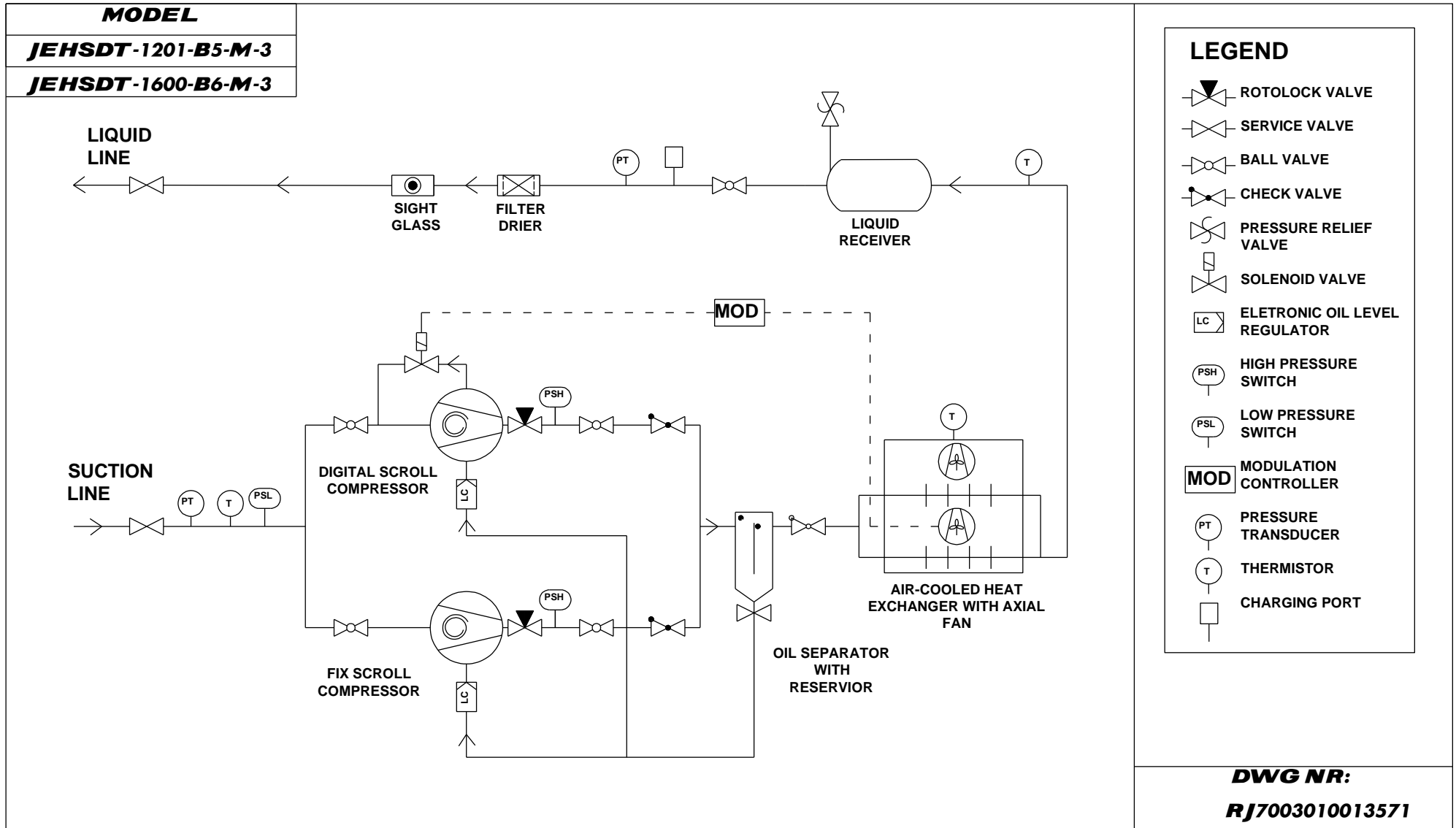


Figure 24: Declaration of Conformity





Declaration of Conformity		
According to SI 2016 No. 1105 SCHEDULE 11, SI 2010 No. 2617 SCHEDULE 1		
We:	J & E Hall Limited Trading as J & E Hall International	
of:	Questor House, 191 Hawley Road, Dartford, Kent, DA1 1PU, United Kingdom	
Declare under sole responsibility that		
The Product:	Refrigeration Condensing Unit	
Model Designations:	JEHSDT-1200-B5-M-3 JEHSDT-1600-B6-M-3 JEHSDT-1201-B5-M-3	
Description:	Digital Twin Commercial Condensing Units for Medium Temperature Applications	
SI 2016 No. 1105 Conformity Assessment Procedure Followed:	Module A2	
Description of the pressure equipment constituting the assembly:		
Part description	Conformity assessment followed	
Pressure switch	Module B + D	
Liquid receiver	Module E	
Oil separator	Module H1	
Pressure Relief Valve	Module B + D	
Filter drier	SEP	
Condenser	SEP	
Sight glass & Valves	SEP	
Flexible hose, System piping & Pressure accessories	SEP	
The object of the declaration described above is in conformity with the following statutory requirements and implementing measures:		
SI 2016 No. 1105:	The Pressure Equipment (Safety) Regulations	
Commission Regulation (EU) 2015/1095:	Commission Regulation (EU) 2015/1095 of 5 May 2015 implementing Directive 2009/125/EC of the European Parliament and of the Council with regard to ecodesign requirements for professional refrigerated storage cabinets, blast cabinets, condensing units and process chillers	
It has been designed and manufactured to the following designated standards and technical specifications:		
BS EN 60335-1:	Household and similar electrical appliances. Safety. General requirements	
BS EN 60335-2-89:	Household and similar electrical appliances. Safety. Particular requirements for commercial refrigerating appliances with an incorporated or remote refrigerant unit or compressor	
BS EN 13215:	Condensing units for refrigeration. Rating conditions, tolerances and presentation of manufacturer's performance data	
DG-0001:	Pressure Equipment	
SI 2016 No. 1105 conformity assessment was carried out by Hartford Steam Boiler UK (Approved Body Number: 2561), 9th Floor, Chancery Place, 50 Brown Street, Manchester M2 2JT, United Kingdom with Marking Permission HSB UK-22-09-004 issued.		
Signed:		
Name:	Andrew Bowden	
Position:	Managing Director	
Location:	J & E Hall Limited, Questor House, 191 Hawley Road, Dartford, Kent, DA1 1PU	
Date:	11/12/2024	
<hr/>		
Form: JEH-DOC-020-03	Questor House, 191 Hawley Road, Dartford, Kent, DA1 1PU	Page 1 of 1

Figure 25: Declaration of Incorporation

Declaration of Incorporation		
According to SI 2008 No. 1597 Annex II		
We:	J & E Hall Limited Trading as J & E Hall International	
of:	Questor House, 191 Hawley Road, Dartford, Kent, DA1 1PU, United Kingdom	
Declare that for below		
Product	Refrigeration Condensing Unit	
Model Designations:	JEHSDT-1200-B5-M-3 JEHSDT-1600-B6-M-3 JEHSDT-1201-B5-M-3	
Description:	Digital Twin Commercial Condensing Units for Medium Temperature Applications	
The following essential health and safety requirements of The Supply of Machinery (Safety) Regulations 2008 (SI 2008 No. 1597) are applied and fulfilled:		
1.1.1 – 1.1.2 – 1.1.3 – 1.1.5 – 1.2.1 - 1.2.6 - 1.3.2 – 1.3.3 – 1.3.4 – 1.3.7 – 1.3.8.2 – 1.4.1 – 1.4.2.1 – 1.5.1 – 1.5.2 – 1.5.13 – 1.7.1.1 – 1.7.2 – 1.7.3 – 1.7.4		
The relevant technical documentation has been compiled in accordance with Annex VII (PART 7 of SCHEDULE 2) part B of SI 2008 No. 1597.		
The partly completed machinery is also in conformity with below enactments:		
SI 2016 No. 1105 :	The Pressure Equipment (Safety) Regulations.	
Commission Regulation (EU) 2015/1095 :	Commission Regulation (EU) 2015/1095 of 5 May 2015 implementing Directive 2009/125/EC of the European Parliament and of the Council with regard to eco-design requirements for professional refrigerated storage cabinets, blast cabinets, condensing units, and process chillers.	
The relevant information can be transmitted in electronic form in response to a reasoned request by the national authorities.		
The partly completed machinery must not be put into service until the final machinery into which it is to be incorporated has been declared in conformity with the provisions of these Regulations, where appropriate.		
The legal representative authorised to compile the relevant technical documentation is J & E Hall Limited, Questor House, 191 Hawley Road, Dartford, Kent, DA1 1PU, United Kingdom.		
Signed:		
Name:	Andrew Bowden	
Position:	Managing Director	
Location:	J & E Hall Limited, Questor House, 191 Hawley Road, Dartford, Kent, DA1 1PU, United Kingdom	
Date:	11/12/2024	
<hr/>		
Form: JEH-DOI-022-03	Questor House, 191 Hawley Road, Dartford, Kent, DA1 1PU	Page 1 of 1

EU Declaration of Conformity

According to DIRECTIVE 2014/68/EU ANNEX IV, DIRECTIVE 2009/125/EC ANNEX VI



We: J & E Hall Limited Trading as J & E Hall International
of: Questor House, 191 Hawley Road, Dartford, Kent, DA1 1PU, United Kingdom
Declare under sole responsibility that
The Product: Refrigeration Condensing Unit
Model Designations: JEHSDT-1200-B5-M-3 JEHSDT-1600-B6-M-3 JEHSDT-1201-B5-M-3
Description: Digital Twin Commercial Condensing Units for Medium Temperature Applications
DIRECTIVE 2014/68/EU Conformity Assessment Procedure Followed: Module A2

Description of the pressure equipment constituting the assembly:

Part description	Conformity assessment followed
Pressure switch	Module B + D
Liquid receiver	Module E
Oil separator	Module H1
Pressure Relief Valve	Module B + D
Filter drier	SEP
Condenser	SEP
Sight glass & Valves	SEP
Flexible hose, System piping & Pressure accessories	SEP

The object of the declaration described above is in conformity with the following Union harmonisation legislation:

- DIRECTIVE 2014/68/EU : On the harmonisation of the laws of the Member States relating to the making available on the market of pressure equipment.
- Commission Regulation (EU) 2015/1095 : Commission Regulation (EU) 2015/1095 of 5 May 2015 implementing Directive 2009/125/EC of the European Parliament and of the Council with regard to ecodesign requirements for professional refrigerated storage cabinets, blast cabinets, condensing units, and process chillers.

It has been designed and manufactured to the following harmonised standards and technical specifications:



- BS EN 60335-1 : Household and similar electrical appliances. Safety. General requirements.
- BS EN 60335-2-89 : Household and similar electrical appliances. Safety. Particular requirements for commercial refrigerating appliances with an incorporated or remote refrigerant unit or compressor.
- BS EN 13215 : Condensing units for refrigeration. Rating conditions, tolerances, and presentation of manufacturer's performance data.
- DG-0001 : Pressure Equipment.

DIRECTIVE 2014/68/EU conformity assessment was carried out by Hartford Steam Boiler Ireland Limited (Notified Body number: 2833) 28 Windsor Place, Lower Pembroke Street, Dublin 2, DO2 H328, Ireland with Marking Permission HSB IE 23-10-004 issued.

Signed:

Name: Andrew Bowden
Position: Managing Director
Location: J & E Hall Limited, Questor House, 191 Hawley Road, Dartford, Kent, DA1 1PU, United Kingdom
Date: 11/12/2024

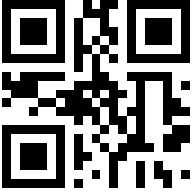
Figure 27: EU Declaration of Incorporation

Declaration of Incorporation			
According to DIRECTIVE 2006/42/EC Annex II			
We:	J & E Hall Limited Trading as J & E Hall International		
of:	Questor House, 191 Hawley Road, Dartford, Kent, DA1 1PU, United Kingdom		
Declare that for below			
Product	Refrigeration Condensing Unit		
Model Designations:	JEHSDT-1200-B5-M-3 JEHSDT-1600-B6-M-3 JEHSDT-1201-B5-M-3		
Description:	Digital Twin Commercial Condensing Units for Medium Temperature Applications		
The following essential health and safety requirements of the Machinery Directive (DIRECTIVE 2006/42/EC) are applied and fulfilled:			
1.1.1 – 1.1.2 – 1.1.3 – 1.1.5 – 1.2.1 - 1.2.6 - 1.3.2 – 1.3.3 – 1.3.4 – 1.3.7 – 1.3.8.2 – 1.4.1 – 1.4.2.1 – 1.5.1 – 1.5.2 – 1.5.13 – 1.7.1.1 – 1.7.2 – 1.7.3 – 1.7.4			
The relevant technical documentation has been compiled in accordance with part B of Annex VII of DIRECTIVE 2006/42/EC.			
The partly completed machinery is also in conformity with below Directives and Regulations:			
DIRECTIVE 2014/68/EU :		On the harmonisation of the laws of the Member States relating to the making available on the market of pressure equipment.	
Commission Regulation (EU) 2015/1095 :		Commission Regulation (EU) 2015/1095 of 5 May 2015 implementing Directive 2009/125/EC of the European Parliament and of the Council with regard to eco-design requirements for professional refrigerated storage cabinets, blast cabinets, condensing units, and process chillers.	
The relevant information can be transmitted in electronic form in response to a reasoned request by the national authorities.			
The partly completed machinery must not be put into service until the final machinery into which it is to be incorporated has been declared in conformity with the provisions of DIRECTIVE 2006/42/EC, where appropriate.			
The legal representative authorised to compile the relevant technical documentation is TEWIS SMART SYSTEMS, S.L.U, Auguste y Louis Lumière, 26 Parque tecnológico, Paterna, Valencia, Spain.			
Signed:			
Name:	Andrew Bowden		
Position:	Managing Director		
Location:	J & E Hall Limited, Questor House, 191 Hawley Road, Dartford, Kent, DA1 1PU, United Kingdom		
Date:	11/12/2024		
Form: JEH-DOI-012-03		Questor House, 191 Hawley Road, Dartford, Kent, DA1 1PU	
		Page 1 of 1	

THIS PAGE IS LEFT BLANK INTENTIONALLY

THIS PAGE IS LEFT BLANK INTENTIONALLY

THIS PAGE IS LEFT BLANK INTENTIONALLY



RJ0110030009850

J & E Hall Limited
Hansard Gate
West Meadows
Derby, DE21 6JN
England

Tel: + 44 (0) 1332 253400
Fax: + 44 (0) 1332 371061
Email: helpline@jehall.co.uk
www.jehall.com

Issue: 01.01.2025

